



LSI LASTEM data loggers share a range of common accessories for their installation, communication and power supply.

Sensors and data logger arms for indoor applications

M-Log used for temporary applications can be mounted on an arm fixed on a tripod, together with sensors.

	BVA320	Sensors and data logger arm. Fixing to BVA304 tripod or to wall	
		Dimensions	850x610x150 mm
		Number of sensors	N.6 using threaded screws + N.1 ring for ESU403.1-EST033 sensors
		Weight	0.5 kg
	BVA315	Sensors and N.2 data logger arm. Fixing to BVA304 tripod	
		Dimensions	400x20x6 mm
		Number of sensors	N.22 using threaded screws + support for N.4 ESU403.1-EST033 sensors
		Weight	1.6 kg
	BVA304	Three arm tripod	
		Occupied area size	Max 1100x1100 mm
		Maximum height	1600 mm
		Weight	1.6 kg
		Bag for transportation	Included

Power supplies



When the data logger (see Compatibility) isn't supplied with an ELF box, we recommend having external power supply units.

	BSC015	Power supply converter/battery charger for indoor applications.	
		Voltage	230 V AC -> 9 V DC (1.8 A)
		Connection	On data logger power plug
		Protection degree	IP54
		Compatibility	M-Log (ELO009)
	DEA261 DEA261.1	Power supply converter/battery charger for indoor applications to data logger	
		Voltage	10W-90..264V AC->13.6 V DC (750 mA)
		Connection	DEA261: with 2C connector DEA261.1: free wires to data logger terminal board
		Protection degree	IP54
		Compatibility	DEA261: E-Log DEA261.1: E-Log, Alpha-Log, ALIEM

	DEA251	Power supply converter/battery charger for outdoor applications. N.2 outputs	
		Voltage	85...264 V AC -> 13.8 V DC
		Power	30 W
		Max output current	2 A
		Connection to sensors or data logger	On free terminals board
		Protection degree	IP65
		Protections	<ul style="list-style-type: none"> • Short Circuit • Overvoltage • Overcurrent
		Operative temperature and humidity	-30...+70 °C ; 20...90 %
		Compatibility	E-Log, Alpha-Log, ALIEM
	DYA059	Bracket for DEA251 on poles of 45...65 mm diameter	

RS485 modules

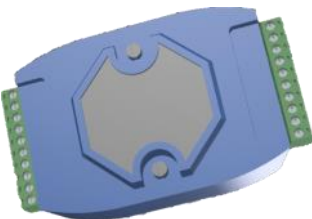
Required to connect RS485 sensors (up to 3 signals) to Alpha-Log's RS485 port.

	TXMRA0031	Three signal RS485 active star wiring hub. The unit has three independent RS485 input and output channels, each with their own driver, which can transmit signals across 1200 m of cable on each channel.	
		Input	N.3 RS485 Channel: Data+, Data-
		Output	N.1 RS485 Channel: Data+, Data-
		Speed	300...115200 bps
		ESD protection	Yes
		Power supply	10...40 V DC (not insulated)
		Power consumption	2.16 W
	EDTUA2130	Three signal RS485 active star wiring hub.	
		Input	N.3 RS485 Channel: Data+, Data-
		Output	N.1 RS485 Channel: Data+, Data-
		Maximum current	16 A
		Voltage	450 V DC
		Protection degree	IP68

Radio signals receiver



	EXP301	Radio signal receiver from radio sensors or from EXP820 RS-232 Output compatible with data loggers (M/E-Log) <ul style="list-style-type: none"> • Maximum number of receivable sensors 200 • Battery NiCd 9 V • Power supply 12 V DC • Antenna included
	DWA601A	Serial cable L=10 m for connection of EXP301 to E/M-Log data logger RS-232 port
	DYA056	Support for EXP301 to pole D=45...65mm

Radio signals repeaters

	EZB322	Zig-Bee radio signals repeater	
		Mounting	Universal AC socket
		Power supply	85...265 V AC, Universal AC socket
		Protection degree	IP52
		Environmental limits	0...70°C
		Compatibility	E-Log radio (ELO3515)
	EXP401	IP64 radio signals repeater "Store and forward". Power supply: 12 V DC	
	DEA260.2	Power supply 230->13,8V 0,6A for EXP401 repeater	
	EXP402	IP65 radio signals repeater "Store and forward". Power supply: 12 V DC	
	DYA056	Support for EXP401-402 to pole D=45...65mm	
	DWA505A	Cable for EXP402, L=5 m	
	DWA510A	Cable for EXP402, L=10 m	

Batteries

External batteries are required for E-Log, Alpha-Log operation when not powered from the mains and or to increase the M-Log battery life. Batteries are usually mounted inside ELF boxes and connected to the data logger using the terminal power supply input.

	MG0558.R	12 V Pb 18 Ah battery	
		Type	Rechargeable Sealed Lead-Acid
		Dimensions	181x76x167 mm
		Weight	6 kg
		Compatibility	ELF345-345.1-340-340.1-340.5-340.8 box
		Operating temperature	<ul style="list-style-type: none"> • Charge -15°C to 40 °C • Discharge -15°C to 50 °C • Storage -15°C to 40 °C
	MG0560.R	12 V Pb 44Ah battery	
		Type	Rechargeable Sealed Lead-Acid
		Dimensions	151x65x94 mm
		Weight	13.5 kg
		Compatibility	ELF345-345.1-340-340.1-340.5-340.8 box
		Operating temperature	<ul style="list-style-type: none"> • Charge -15 °C to 40 °C • Discharge -15 °C to 50 °C • Storage -15 °C to 40 °C

Mini-DIN Adapters

To connect sensors with free-wires to data loggers with min-DIN input (ELO009), these adapters are needed:

	CCDCA0010	Terminal board/mini-DIN adapter+cable	
	CCDCA0020	N. contacts	CCDCA0010: 4 + shield (for digital sensor) CCDCA0020: 7 + shield (for analogic sensor)
		Cable	L=2 m

RS232 cables, USB interface

To connect data loggers to PC via RS232 or USB cable. In each pack of M-Log and E-Log , the ELA105.R serial cable and the DEB518.R USB adapter are included.

	ELA105.R	L= 1,8 m serial cable Included in each M-Log and E-Log pack
	DEB518.R	RS232->USB converter Included in each M-Log and E-Log pack

RS485 converters, TCP/IP

To obtain a long cable (more than 1 Km) between the data logger and the PC. It is possible to use a RS232-485 converter. A TCP/IP connection to the Ethernet web, allows to send data to the PC within a network also connected via the Internet. These devices can be mounted inside ELF boxes.

	DEA504.1	RS232<->RS485/422 422 converter with electrical protections	
		Insulation (optically)	Optically insulated (2000 V)
		Insulation (surge protection)	From electrostatic discharge (25KV ESD)
		Bit rate	300 bps...1 M bps
		RS232 connector	DB9 female
		RS422/485 connector	DB9 male, 5-pin terminal
		Power supply	9...48 V DC (power supply included)
		Fixing	DIN bar
		Cable	DB9M/DB9F (included)
	MN1510.20R	Cable LAN Category 5 to connect DEA504 converters. L= 20 m	
	MN1510.25R	Cable LAN Category 5 to connect DEA504 converters. L= 25 m	
	MN1510.50R	Cable LAN Category 5 to connect DEA504 converters. L= 50 m	
	MN1510.200R	Cable LAN Category 5 to connect DEA504 converters. L= 200 m	

	DEA553	Industrial secure serial port to Ethernet device server with 1xRS-232/422/485 and 2x10/100Base-T(X)	
		Input	RS232/422/485 (DB9)
		Output	Ethernet 10/100Base-T(x) Auto MDI/ MDIX
		Protocols	ICMP, IP, TCP, UDP, DHCP, BOOTP, SSH, DNS, SNMP, V1/V2c, HTTPS, SMTP
		Power supply	12...48 V DC
		Consumption	1.44 W
		Operative Temperature	-40...70 °C
		Fixing	DIN bar
		Protection degree	IP30
		Weight	0,227 kg
	DEA509	Gateway Modbus-TCP. Modbus-RTU in Modbus TCP converter	
		Input	RS232/422/485 (DB9)
		Output	Ethernet 10/100 M
		ESD protection	15 KV for serial port
		Magnetic protections	1.5 KV for Ethernet port
		Power supply	12...48 V DC
		Consumption	200 mA @ 12V DC, 60 mA@ 48V DC
		Operative Temperature	0...60 °C
		Fixing	DIN bar
		Weight	0.34 kg

Converter RS232/RS485 -> optical fibre

	TXMPA1151	Serial converter RS232 / optical fibre mono modal
	TXMPA1251	Serial converter R485 / optical fibre mono modal



Dropping resistors

	EDECA1001	Five 50 ohm-resistors kit (1/8 W, 0.1%, 25 ppm) to convert 4...20 mA -> 200...1000 mV
--	------------------	---

Modem GPRS, 3G, 4G. UMTS Router. Wi-Fi Module

For remote connections, 3G-4G modems are available. Via modem, is possible to send (“push mode”) data to FTP server or, using the program P1-CommNET, to LSI LASTEM GIDAS database. These devices can be mounted inside ELF boxes.

	DEA718.3	Modem GPRS - GSM-850 / EGSM-900 / DCS-1800 / PCS-1900 MHz Quad-Band. GPRS class 10	
		Operative temperature	-20...70 °C
		Power supply	9...24 V DC from data logger
		Consumption	Sleep: 30 mA, during com. 110 mA
		Weight	0.2 kg
		Compatibility	E-Log
	ELA110	Connection cable between E-Log and DEA718.3 modem	
	MC4101	Fixing bar for DEA718.3 in ELF boxes	
	DEA609	Modem adapter DEA718.3 / external antenna DEA611	
	TXCMA2200	Modem 4G/LTE/HSPA/WCDMA/GPRS Quadband/class 10/class12	
		LTE FDD	Download speed 100Mbps Upload speed 50Mbps
		Frequency band (MHz)	850/900/1800/1900MHz
		Input	2 x RS232, 1 x RS485
		Cellular Antenna	Standard SMA female interface, 50 ohm, lightning protection(optional)
		SMS	Yes
		Connection cable to data logger	Included
		Operative Temperature	-35...75 °C
		Power supply	5...36 V DC from data logger
		Consumption @12 V	Sleep: 3 mA. Standby: 40-50 mA. Communication mode: 75-95 mA
		Casing	Iron, IP30
		Mounting	DIN bar
		Weight	0.205 kg
Compatibility	Alpha-Log		
	DEA611	External antenna for 3G, LTE modem TXCMA2200 double gain GPRS/UMTS/LTE	
		Frequencies	GSM/GPRS/EDGE: 850 / 900 / 1800 / 1900 MHz. UMTS/WCDMA: 2100 MHz LTE: 700 / 800 / 1800 / 2600 MHz
		Free license ISM band	Field 869 MHz, UHF Frequency
		Irradiation	Omnidirectional
		Gain	2 dBi
		Power (max)	100 W
		Impedance	50 Ohm
		Cable	L=5 m
		Fixing accessory	Included
		Compatibility	TXCMA2200, DEA718.3 (with DEA609)



	TXMPA3770	High-Gain 2.4 GHz Wi-Fi USB adapter	
		Wireless data rate	Up to 150 Mbps
		Port	USB 2.0
		Security	WEP, WPA, WPA2, WPA-PSK/WPA2-PSY Encryptions
		Standard	IEEE802.11
		Environmental limits	0...40 °C (Not condensing)
		Weight / Dimensions	0.032 kg / 93.5 x 26 x 11 mm
	TXCRB2200	Dual SIM Industrial 4G/LTE Wi-Fi router, 3 models depending on number of LAN ports (e.g. data logger and camera with ethernet) and region covered	
	TXCRB2210		
	TXCRB2200.D		
		Mobile	4G (LTE), 3G
		Max data rate	LTE: 150 Mbps. 3G: 42 Mbps
		WiFi	WPA2-PSK, WPA-PSK, WEP, MAC Filter
		Ethernet WAN port	N.1 (config. to LAN) 10/100 Mbps
		Ethernet LAN port (10/100 Mbps)	<ul style="list-style-type: none"> N.1 (TXCRB2200, TXCRB2200.1) N.4 (TXCRB2210)
		Network protocols	TCP, UDP, IPv4, IPv6, ICMP, NTP, DNS, HTTP, HTTPS, FTP, SMTP, SSL v3, TLS, ARP, VRRP, PPP, PPPoE, UPnP, SSH, DHCP, Telnet, SNMP, MQTT, Wake On Lan (WOL)
		Region (operator)	<ul style="list-style-type: none"> TXCRB2200, TXCRB2210: Global TXCRB2200.D: Europe, The Middle East, Africa
		Frequencies	<ul style="list-style-type: none"> TXCRB2200, TXCRB2210: 4G (LTE-FDD): B1, B2, B3, B4, B5, B7, B8, B12, B13, B18, B19, B20, B25, B26, B28. 4G (LTE-TDD): B38, B39, B40, B41. 3G: B1, B2, B4, B5, B6, B8, B19. 2G: B2, B3, B5, B8 TXCRB2200.1: 4G (LTE-FDD): B1, B3, B5, B7, B8, B20. 4G (LTE-FDD): B1, B3, B7, B8, B20. 3G: B1, B5, B8. 2G: B3, B8
		Power supply	9...30 V DC (<5W)
		Operating temperature	-40...75 °C
	Weight	0.125 kg	
	Compatibility	Alpha-Log	
	TXANA3033	Network directional antenna 28dBi	
		Weight / Dimensions	550 g / 110 x 55 mm
		Cable	H=3 m
		Compatibility	TXCRB2200-00.1, TXCRB2210

	TXRMA4640	Satellite Modem (GPS+GLONASS L1 freq.) Thuraya M2M	
		Narrowband IP	UDP and TCP/IP
		Frequency band	TX 1626.5 to 1675.0 MHz RX 1518.0 to 1559.0 MHz
		Typical latency	< 2 s 100 bytes
		Power	10...32 V DC
		Wi-Fi	IEEE 802.11 B/G, 2.4 GHz
		Weight / Size (L x W x H)	< 900 g / 170 x 130 x 42 mm
		Operative temperature	-40°C...+71 °C
		Support to pole	DYA062
	TXCRA1300	Industrial router 3G/LTE dual SIM, removable magnetic antenna. Input RS232/485 for communication of independent devices	
		Max data rate	3G: 14 Mbps
		SMS	Si
		Ethernet LAN port	N.1 LAN port, 10/100BT
		Network protocols	PPP, PPPoE, TCP, UDP, DHCP, ICMP, NAT, DMZ, RIPv1/v2, OSPF, DDNS, VRRP, HT TP, HTTPs, DNS, ARP, QoS, SNTP, Telnet
		Power supply	9...26 V DC (<5W)
		Operating temperature	-40...75 °C
		Compatibility	M-Log, E-Log
		Communication ports	RS232, RS485
		Antenna	3G/2G Omnidirectional Quad-Band included + second connector
			TXRGA2100
Wi-Fi	N.1 radio IEEE 802.11a/b/g/n, MIMO		
Sensitivity	Receiver: -92 dBm for 802.11 b/g/n and -96 dBm for 802.11a/n		
Ethernet LAN Port	N.1 LAN port Gigabit 10/100/1000		
Power Supply	9...48 V DC		
Operative temperature	-20...60 °C		
Compatibilità	Alpha-Log		
Flat antennas	N.2 3dBi@2,4 GHz/4dBi@5GHz		
Mounting on DIN bar	With kit MAOFA1001		
	TXANA1125	Omnidirectional antenna SISO "stick" 2 dB	
		Bandwidth	Broad 698..3800 MHz
		Gain	2 dB
		Length	16 cm
		Cable	3 m with SMA connector
		Mounting	Pole/wall mounting kit included

	TXANA1125 .1	Omnidirectional antenna SISO "stick" 6 dB	
		Bandwidth	2.4 GHz
		Gain	6 dB
		Length	25 cm
		Cable	2 m with N-f/RSMA connector
		Mounting	Pole/wall mounting plate included



Long distance VHF radio

VHF radios allow easy, cost-free connections, several kilometers away. Via radio it is possible to connect several data loggers with MASTER/SLAVE logic or to connect a data logger to a PC. These devices can be mounted inside ELF boxes.

	TXRMA2132	160 MHz radio modem for PC or data logger connection, VHF-500 mW erp; includes 3 elements Yagi antenna. Transmitting part of the system, connected with ELA110+ELA105 to data logger, included in M-Log and E-Log.	
		Operating band	169.400...169.475 MHz
		Output power	500 mW ERP
		Number of channels	12.5 – 25 – 50 kHz
		Radio data rate (Tx/Rx)	4.800 bps@12.5kHz, 9600 bps@25kHz, 19200 bps @50 kHz
		Power supply	9...32 V DC
		Consumption	140 mA (Rx)
		Operative temperature	-30...70 °C
		Antenna	Included. N.3 elements antenna Yagi. L=10 m cable
		Line-of-sight	7...10 km
		Weight	0.33 kg without antenna
		Communication port	RS232, RS485
			TXRMA2131
Main features	See TXCMA2132		
Antenna	Included Dipole antenna L=5 m cable		
	ELA110	Connection cable radio/data logger	
	ELA105	Serial cable L=1.8 m. To be quoted to connect TXMA2131 to PC. Included in each package of M-Log and E-Log for data logger connection.	
	DEA260.1	230 V AC/12V DC power supply for radio TXRMA2131 PC side	
	DEA605	Serial adapter null-modem 9M/9F	
	DEA606.R	Serial adapter null-modem 9M/9M	

Solar panel

For applications where mains power is not available or where a double power supply is required, the data logger can be powered by a photovoltaic panel. In these cases it is advisable to place the data logger inside an ELF345-345.1 box that includes DYA115 regulator that doesn't have to be supplied separately. When a solar panel supply is present, an external battery must be housed in the ELF345 box model MG0558.R (18 Ah) or MG0560.R (44 Ah), chosen according to the autonomy required and the availability of hours of sunshine. The solar panel is mounted on a pole through a tiltable support (DYA064). Alternatively, the ELU001 box is available, which includes a 20 W panel mounted on its front panel.

	DYA101	65 Watt solar panel	
		Power	65 Wp
		Operative voltage (VMP)	15 V
		VOC voltage	22.4 V
		Dimensions	813x535 mm
		Weight	5.2 kg
		Tecnology	Monocrystalline
		Frame material	Aluminium
		Cable	L=5 m
	Regulator (DYA115)	<ul style="list-style-type: none"> • Battery Voltage: 12/24V • Charge/Discharge Current: 10 A • Battery type: Lead/Acid • Float voltage: 13.7 V • Auto Power Off Voltage: 10.7 V • Auto Reconnect Voltage: 12.6 V • Self-consumption: < 10 mA • USB Output: 5 V /1.2 A Max • Operating temperature: -35...60 °C • included inside ELF345-345.1 boxes • Inside Alpha-Log 	
	DYA064	Tiltable support for solar panel fixing to poles of diam. 45...65 mm Weigth: 1.15 kg	

Shockproof case to contain data loggers in portable applications





For portable applications, data loggers can be mounted inside IP66 cases to be protected against shocks, water, dust and atmospheric agents. Inside the case can be also be housed the communication device.



	ELF432	Portable IP66 shockproof case. Complete with rechargeable battery (18 Ah) and power supply/battery charger (230 V AC/13,8 V DC)	
		Dimensions	520 x 430 x 210 mm
		Weight	12 kg
		Compatibility	E-Log, Alpha-Log

IP66 boxes for data logger fix installations

For fix outdoor installations, data loggers can be mounted inside IP66 enclosures that give protection against shocks, water, dust and atmospheric agents. Each box houses the relative power supply system as well as specific accessories, and has the predisposition to house the communication device that can be chosen from the list of Accessories. Each box can be equipped with a support for pole or wall fixing.



	ELF345	IP66 box. Complete with regulator for photovoltaic panels. Compatibility with 18 or 44 Ah batteries	
		Power supply	From solar panel using regulator
		Solar panel regulator	Included
		Dimensions	H 502 x L 406 x D 230 mm
		Weight	7 kg (battery excluded)
		Material	Fiberglass
		Compatible batteries (not included)	MG0558.R (18 Ah), MG0560.R (44 Ah)
		Compatibility	E-Log, Alpha-Log
	ELF345.1	IP66 box. Complete with regulator for photovoltaic panels and 85-264 V AC battery charger power supply. Compatibility with 18 or 44 Ah batteries.	
		Solar panel regulator	Included
		Power supply	85-264 V AC-> 13.8 V DC Thermal magnetic switch. Power: 50W
		Dimensions	H 502 x L 406 x D 230 mm
		Weight	17.5kg (battery excluded)
		Material	Fiberglass
		Compatibility	E-Log, Alpha-Log
	ELF345.3	IP66 box for Alpha-Log connection to photovoltaic panels. Compatibility with 18 or 44 Ah batteries	
		Power supply	From solar panel using regulator inside Alpha-Log
		Dimensions	H 502 x L 406 x D 230 mm
		Weight	7 kg (battery excluded)
		Material	Fiberglass
		Compatible batteries (not included)	MG0558.R (18 Ah), MG0560.R (44 Ah)
		Compatibility	Alpha-Log
	ELK340	IP66 box. Complete with 85-240 V AC-> 13.8 V DC power supply (30 W) and 2 Ah battery.	
		Power supply	85-240 V AC-> 13.8 V DC Thermal magnetic switch. Power: 30W
		Dimensions	H 445 mm x L 300 mm P 200 mm
		Weight	5 kg
		Material	Polyester
		Battery	2 Ah rechargeable, included
		Compatibility	E-Log, Alpha-Log, ALIEM

	<p>ELF340.10</p>	<p>IP66 box. Complete with 85-264 V AC-> 13.8 V DC power supply and 2 Ah battery and 230/24V transformer. With provision for installation of Relays for actuations (MG3023.R type) and IN-OUT terminal for analogue signals</p> <table border="1" data-bbox="576 365 1497 645"> <tr> <td>Power supply</td> <td>85-264 V AC-> 13.8 V DC 30W 230V AC/24V AC 40VA Thermal magnetic</td> </tr> <tr> <td>Provision for Relays (not included)</td> <td>Up to N.5 Relays (MG3023.R type)</td> </tr> <tr> <td>IN-OUT signals terminal board</td> <td>Terminal for analog signals input N.7 IN signals N.7 OUT signals</td> </tr> </table>	Power supply	85-264 V AC-> 13.8 V DC 30W 230V AC/24V AC 40VA Thermal magnetic	Provision for Relays (not included)	Up to N.5 Relays (MG3023.R type)	IN-OUT signals terminal board	Terminal for analog signals input N.7 IN signals N.7 OUT signals						
Power supply	85-264 V AC-> 13.8 V DC 30W 230V AC/24V AC 40VA Thermal magnetic													
Provision for Relays (not included)	Up to N.5 Relays (MG3023.R type)													
IN-OUT signals terminal board	Terminal for analog signals input N.7 IN signals N.7 OUT signals													
	<p>ELF340.8</p>	<p>IP66 box. Complete with 85-264 V AC-> 13.8 V DC power supply and terminal board for up to N.3 RS485 signals. Compatibility with 18 or 44 Ah batteries. Used to receive digital signals</p> <table border="1" data-bbox="576 745 1497 1039"> <tr> <td>Power supply</td> <td>85-264 V AC-> 13.8 V DC 50W Thermal magnetic</td> </tr> <tr> <td>Dimensions</td> <td>H 502 x L 406 x D 230 mm</td> </tr> <tr> <td>Weight</td> <td>7,5 kg</td> </tr> <tr> <td>Battery</td> <td>2Ah rechargeable, included</td> </tr> <tr> <td>Compatibility</td> <td>E-Log, Alpha-Log</td> </tr> </table>	Power supply	85-264 V AC-> 13.8 V DC 50W Thermal magnetic	Dimensions	H 502 x L 406 x D 230 mm	Weight	7,5 kg	Battery	2Ah rechargeable, included	Compatibility	E-Log, Alpha-Log		
Power supply	85-264 V AC-> 13.8 V DC 50W Thermal magnetic													
Dimensions	H 502 x L 406 x D 230 mm													
Weight	7,5 kg													
Battery	2Ah rechargeable, included													
Compatibility	E-Log, Alpha-Log													
	<p>ELF344</p>	<p>IP66 box. Complete with 85-264 V AC-> 13.8 V DC power supply, 2Ah battery and 230 V AC/24 V AC transformer for heated sensors</p> <table border="1" data-bbox="576 1120 1497 1469"> <tr> <td>Power supply</td> <td>85-264 V AC-> 13,8 V DC 2A 30W</td> </tr> <tr> <td>Transformer</td> <td>230V AC/24V AC 4.1 A 100VA</td> </tr> <tr> <td>Dimensions</td> <td>H 502 x L 406 x D 230 mm</td> </tr> <tr> <td>Weight</td> <td>7.5 kg</td> </tr> <tr> <td>Battery</td> <td>2Ah rechargeable, included</td> </tr> <tr> <td>Compatibility</td> <td>E-Log, Alpha-Log</td> </tr> </table>	Power supply	85-264 V AC-> 13,8 V DC 2A 30W	Transformer	230V AC/24V AC 4.1 A 100VA	Dimensions	H 502 x L 406 x D 230 mm	Weight	7.5 kg	Battery	2Ah rechargeable, included	Compatibility	E-Log, Alpha-Log
Power supply	85-264 V AC-> 13,8 V DC 2A 30W													
Transformer	230V AC/24V AC 4.1 A 100VA													
Dimensions	H 502 x L 406 x D 230 mm													
Weight	7.5 kg													
Battery	2Ah rechargeable, included													
Compatibility	E-Log, Alpha-Log													
	<p>ELK347</p>	<p>IP66 box. Complete with 85-240 V AC-> 13,8 V DC power supply, 2Ah battery and 85-260 V AC -> 24 V DC transformer for ALL IN ONE heated version sensors</p> <table border="1" data-bbox="576 1550 1497 1917"> <tr> <td>Power supply</td> <td>85-240 V AC -> 13,8 V DC 30W</td> </tr> <tr> <td>Transformer</td> <td>85-260 V AC -> 24 V DC 150 W</td> </tr> <tr> <td>Dimensions</td> <td>H 445 mm x L 300 mm P 200 mm</td> </tr> <tr> <td>Weight</td> <td>5,5 kg</td> </tr> <tr> <td>Battery</td> <td>2 Ah rechargeable, included</td> </tr> <tr> <td>Compatibility</td> <td>Alpha-Log</td> </tr> </table>	Power supply	85-240 V AC -> 13,8 V DC 30W	Transformer	85-260 V AC -> 24 V DC 150 W	Dimensions	H 445 mm x L 300 mm P 200 mm	Weight	5,5 kg	Battery	2 Ah rechargeable, included	Compatibility	Alpha-Log
Power supply	85-240 V AC -> 13,8 V DC 30W													
Transformer	85-260 V AC -> 24 V DC 150 W													
Dimensions	H 445 mm x L 300 mm P 200 mm													
Weight	5,5 kg													
Battery	2 Ah rechargeable, included													
Compatibility	Alpha-Log													

	DYA074	Support for IP66 enclosures H 502 x L 406 x P160 mm to pole Ø 45...65 mm
	DYA072	Support for IP66 enclosures H 502 x L 406 x P 160 mm to wall
	DYA148	Support for two IP66 enclosures H 502 x L 406 x P160 mm to pole Ø 45...65 mm
	DYA081	Door lock for ELFxxx boxes
	MAPSA1201	Protection tile for ELFxxx boxes. Dimensions: 500 x 400 x 230 mm
	SVSKA1001	Fixing kit for Alpha-Log in ELFxxx boxes when E-Log is already installed
	MAGFA1001	Cable gland for ELF340-340.7-345-345.1-345.3-344-347 box and RJ45 / Ethernet cable

Carrying cases

To transport data loggers and their accessories, LSI LASTEM supplies the following cases.

	BWA314	Shockproof case, watertight (52x43x21 cm) for data loggers and probes Weight: 3.9 kg
	BWA319	Shockproof case with wheels, watertight (68x53x28 cm) for data loggers and probes Weight: 7 kg
	BWA047	Soft bag for data logger transport Weight: 0.8 kg
	BWA048	Bag to transport BVA304 tripod and stands Weight: 0.4 kg

Relay

Data logger versions with terminal inputs can switch external devices on/off via their digital outputs. The voltage available at the outputs corresponds to the supply voltage of the data logger (normally 12 V DC). In order to convert the output into a clean On/Off contact, LSI LASTEM provides relay suitable for mounting inside ELF boxes.

	MG3023.R	Relay for On-Off actuation of the digital output. DPDT type.																
		<table border="0"> <tr> <td>Maximum switching voltage contact</td> <td>250 V AC/DC</td> </tr> <tr> <td>Minimum switching voltage contact</td> <td>5 V (at 10 mA)</td> </tr> <tr> <td>Min. switching current contact</td> <td>10 mA (At 5 V)</td> </tr> <tr> <td>Limiting continuous current contact</td> <td>8 A</td> </tr> <tr> <td>Typical input current coil</td> <td>33 mA</td> </tr> <tr> <td>Coil voltage</td> <td>12 V DC</td> </tr> <tr> <td>Protective circuit</td> <td>Damping diode</td> </tr> <tr> <td>Operating voltage display</td> <td>Yellow LED</td> </tr> </table>	Maximum switching voltage contact	250 V AC/DC	Minimum switching voltage contact	5 V (at 10 mA)	Min. switching current contact	10 mA (At 5 V)	Limiting continuous current contact	8 A	Typical input current coil	33 mA	Coil voltage	12 V DC	Protective circuit	Damping diode	Operating voltage display	Yellow LED
Maximum switching voltage contact	250 V AC/DC																	
Minimum switching voltage contact	5 V (at 10 mA)																	
Min. switching current contact	10 mA (At 5 V)																	
Limiting continuous current contact	8 A																	
Typical input current coil	33 mA																	
Coil voltage	12 V DC																	
Protective circuit	Damping diode																	
Operating voltage display	Yellow LED																	
	MG3024.R	<table border="0"> <tr> <td>Maximum switching voltage contact</td> <td>400 V AC/DC</td> </tr> <tr> <td>Minimum switching voltage contact</td> <td>12 V (at 10 mA)</td> </tr> <tr> <td>Min. switching current contact</td> <td>10 mA (At 12 V)</td> </tr> <tr> <td>Limiting continuous current contact</td> <td>12 A</td> </tr> <tr> <td>Typical input current coil</td> <td>62.5 mA</td> </tr> <tr> <td>Coil voltage</td> <td>12 V DC</td> </tr> <tr> <td>Protective circuit</td> <td>Damping diode</td> </tr> <tr> <td>Operating voltage display</td> <td>Yellow LED</td> </tr> </table>	Maximum switching voltage contact	400 V AC/DC	Minimum switching voltage contact	12 V (at 10 mA)	Min. switching current contact	10 mA (At 12 V)	Limiting continuous current contact	12 A	Typical input current coil	62.5 mA	Coil voltage	12 V DC	Protective circuit	Damping diode	Operating voltage display	Yellow LED
Maximum switching voltage contact	400 V AC/DC																	
Minimum switching voltage contact	12 V (at 10 mA)																	
Min. switching current contact	10 mA (At 12 V)																	
Limiting continuous current contact	12 A																	
Typical input current coil	62.5 mA																	
Coil voltage	12 V DC																	
Protective circuit	Damping diode																	
Operating voltage display	Yellow LED																	



USB Drive

	XLA010	USB Pen drive 3.0 Industrial Grade, Flash type MLC	
		Capacity	8 Gb
		Power consumption	0.7 W
		Operative temperature	-40...85 °C
		Vibration	20G @7...2000Hz
		Shock	1500G @ 0.5ms
		MTBF	3 million hours

Data logger protections

	EDEPA1100	Protection unit (SPD) for power line, single phase 230 V.	
		Mounting	DIN bar
		Compatibility	Alpha-Log, E-Log
	EDEPA1101	Protection unit (SPD) for RS-485 communication line.	
		Mounting	DIN bar
		Compatibility	Alpha-Log, E-Log
	EDEPA1102	Protection unit (SPD) for Ethernet communication line.	
		Mounting	DIN bar
		Compatibility	Alpha-Log, G.Re.T.A.

Optical/acoustic signallers

	SDMSA0001	Optical/acoustic signaller for indoor use	
		Lens colour	Red
		Power supply	5...30 V DC
		Protection grade	IP23
		Operative temperature	-20...60 °C
	SDMSA0002	Optical/acoustic signaller for outdoor use with 8 SMT LED	
		Lens colour	Red
		Power supply	10..17 V AC/DC
		Protection grade	IP65
		Operative temperature	-20...55 °C