



LSI LASTEM S.r.l.

Via Ex S.P. 161 Dosso, n.9 - 20090 Settala Premenugo (MI) - Italia

Tel.: (+39) 02 95 41 41

Fax: (+39) 02 95 77 05 94

e-mail: info@lsi-lastem.it

WEB: <http://www.lsi-lastem.it>

CF./P. Iva: (VAT) IT-04407090150

REA:1009921 **Reg.Imprese:** 04407090150



M-Log



User's manual

Update 12/19/2013

Copyright 2011-2013 LSI LASTEM. All rights reserved.

This manual can be modified without notice.

Anybody can copy, print or publish this manual without LSI LASTEM written authorization.

LSI LASTEM reserves the right to modify the product without an immediate revision of this document.

Summary

1	General safety rules	5
2	Foreword.....	6
2.1	Disposal.....	6
2.2	How to contact LSI LASTEM	6
3	Guide to the start.....	7
3.1	Description	7
3.2	Models.....	8
3.3	Mechanical and electrical installation.....	9
3.3.1	Instrument power supply.....	9
3.3.2	Internal rechargeable battery.....	9
3.3.3	Inputs and actuators	10
3.3.4	Single-ended inputs.....	12
3.3.5	Serial communication lines.....	13
3.3.6	Modem power supply.....	14
3.4	Configuring the operative mode	14
3.4.1	Language configuration	15
4	Instrument use.....	16
4.1	Frontal panel overview.....	16
4.2	Using the keyboard	16
4.3	Display informations and controls	18
4.3.1	Input of commands with immediate effect	18
4.3.1.1	Power on and power off the instrument	18
4.3.1.2	Fast acquisition mode.....	18
4.3.1.3	Configuration with automatic recognition of probes	19
4.3.1.4	Record the starting and ending time of data acquisition (Survey n).....	19
4.3.1.5	Reset statistics	19
4.3.1.6	Fast transmission mode.....	20
4.3.1.7	System clock setting.....	20
4.3.2	Product presentation window	20
4.3.3	Instantaneous values of measures	21
4.3.4	Diagnostic information	22
4.3.5	Shutting off the display	27
4.4	Reset button.....	27
4.5	LED’s.....	27
5	M-Log additional features	29
5.1	Starting and running the survey	29
5.1.1	Automatic recognition of probes.....	29
5.1.2	Checking the power supply voltage.....	31
5.2	Acquisition and calculation of measures	31
5.2.1	Acquisition from sensors with serial or radio output.....	32
5.2.2	Acquisition from thermocouples.....	33
5.2.3	Details about the measure acquisition process.....	33
5.2.4	Acquisition from status signals	33
5.2.5	Fast acquisition mode of the measures	34
5.2.6	Activation of sensor control.....	34
5.2.7	Details about calculated measures	35
5.3	Measure elaboration.....	35

5.3.1	Vectorial calculation specific for anemometric quantities.....	36
5.4	Storing elaborated data.....	37
5.4.1	Memory autonomy.....	37
5.5	Actuation logics.....	38
5.5.1	Eolic alarm.....	39
5.5.2	Evaporimeter filling.....	39
5.5.3	Start precipitation alarm.....	39
5.5.4	Flood alarm.....	40
5.5.5	Threshold value compare.....	40
5.5.6	Timer.....	43
5.5.7	Snow level alarm.....	44
5.5.8	System error.....	44
5.6	Communication modes.....	45
5.6.1	RS232 serial port.....	45
5.6.2	Ethernet.....	47
5.6.2.1	DEA550 converter configuration.....	47
5.6.2.2	XPORT configuration (internal Ethernet port).....	48
5.6.3	Data trasmission through GPRS connection.....	50
5.6.3.1	Use of DEA717 GPRS Industrial Plus modem.....	52
5.6.3.2	Use of DEA718 GT863-PY Telit modem.....	52
5.6.4	TTY Protocol.....	52
5.6.5	Modbus Protocol.....	53
5.6.6	M-Log connected like master-slave mode.....	53
5.7	Operating of low energetic consumption.....	55
6	Appendixes.....	56
6.1	Technical specifications.....	56
6.2	Function library for derived calculations.....	59
6.3	Error messages.....	61
6.3.1	Disabling error signalization.....	62
6.3.2	Error found in measure.....	62
6.3.3	Low battery signalization.....	63
6.4	Instrument maintenance.....	63
6.5	Declaration of conformity.....	64

1 General safety rules

Please read the following general safety rules in order to avoid injuries to people and to prevent damages to the product or to products that may be used in connection with it. In order to avoid damages, use this product exclusively according to the instructions herein contained.

Installation and maintenance interventions are to be exclusively carried out by authorized and skilled people only.

Install the instrument in a clean, dry and safe place. Humidity, dust and extreme temperatures may deteriorate or damage the instrument. In such cases, we advise installing the instrument inside a suitable container.

Power the instrument in a suitable manner. Connect the instrument to the power supply indicated in the model in your possession.

Carry out all connections in a suitable manner. Pay strict attention to the connection diagrams supplied with the instrument.

Do not use the product in case of suspected malfunction. In case of suspected malfunction, do not power the instrument; contact authorized technical support immediately.

Before every maintenance of electrical connections, power supply, sensors and computer-equipments:

- **disconnect the power supply,**
- **discharge the electrostatic discharges touching one conductor or one earth apparatus.**

Do not use the product in the presence of water or condensing humidity.

Do not use the product in a potentially explosive atmosphere.

Internal lithium battery. Do not replace the battery with wrong type. Possible explosion risk.

2 Foreword

M-Log datalogger has been designed for environmental applications; it comes from E-Log primarily and utilizes the same use modes and management programs (3DOM, Gidas ...)

Thanks to its low power consumption, its sizes, the range of signals that it can receive, the protection as regards heavy environmental conditions and possible overvoltages, M-Log datalogger is particularly suitable for measurements of weather, water, air quality, indoor and outdoor environmental monitoring applications.

M-Log line is divided in two big typologies (you can find the detailed list of models in §3.2):

- M-Log with inputs suitable to receive sensors with connectors for automatic configuration by means of recognition resistance; it’s suitable for indoor applications (microclimate).
- M-Log with terminal board inputs; it’s suitable for outdoor applications (meteorology).

M-Log can be fitted with a wide range of accessories to enhance its power autonomy, to protect it against extreme weather conditions and for data transmission via RS232/485, USB, Ethernet, modem PSTN/GSM/GPRS.

2.1 Disposal

M-Log is a highly electronic scientific device. In accordance with the standards of environmental protection and collection, LSI LASTEM advises to handle M-Log as waste of electrical and electronic equipment (WEEE). It is therefore not to be collected with any other kind of waste.

LSI LASTEM is liable for the compliance of the production, sales and disposal lines of M-Log, safeguarding the rights of the consumer. Unauthorized disposal will be punished by the law. Dispose of the dead batteries according to the regulations in force

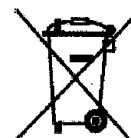

2.2 How to contact LSI LASTEM

In case of problems contact the LSI LASTEM technical support at support@lsi-lastem.it, or fill in the *On-line technical support request* form accessible from the home page of the website www.lsi-lastem.it.

For further information:

- Telephone +39 02 95.414.1
- Address Via ex S.P. 161 – Dosso n. 9 - 20090 Settala Premenugo, Milano
- Home page www.lsi-lastem.it
- Sales info@lsi-lastem.it
- After-sales service support@lsi-lastem.it, riparazioni@lsi-lastem.it

3 Guide to the start

3.1 Description



M-Log is leading-edge datalogger worked out by LSI LASTEM, and thanks to its multi-measurement system it’s suitable for all environmental applications.

The front panel of instrument is equipped with illuminated display (4x20 characters), signalling bright leds, function and arrow keys.

On top side of instrument there are the communication devices (according to the model: serial port or Ethernet output), the Reset key, the socket for connection of external power supply system.

On bottom side we can find the inputs for connection of sensors; according to M-Log model, for connection of sensors, it’s possible to find fix mini-din connectors (models series ELO009), or usual terminal board with pluggable terminals; in last case extract the terminals from their housing using a suitable tool.

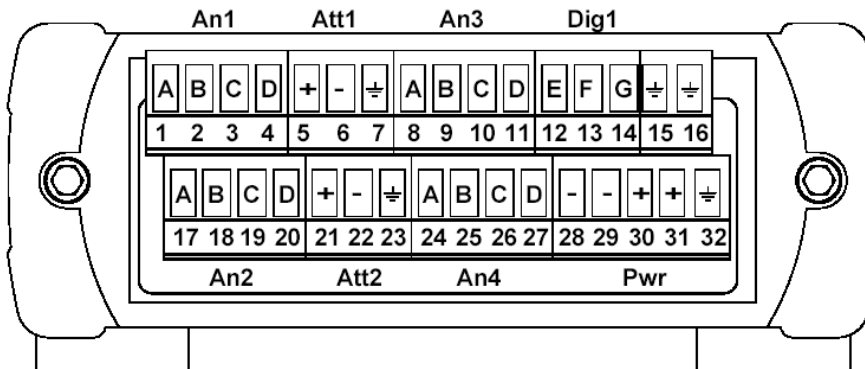

Terminal board with pluggable terminals

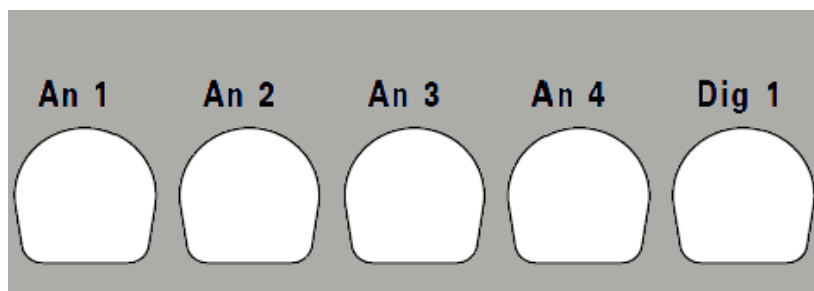

Terminal board with fix mini-din connectors

On back panel of instrument there is a label that carries, in addition to standard information about power supply and radio features, also following information:

- M-Log model;
- Serial number of instrument (univocal number consisting of 8 numerics that marks each datalogger);
- MAC address for models ELO007, equipped with Ethernet output;
- Free space for annotation of used configurations and their connections with sensors connected to datalogger.

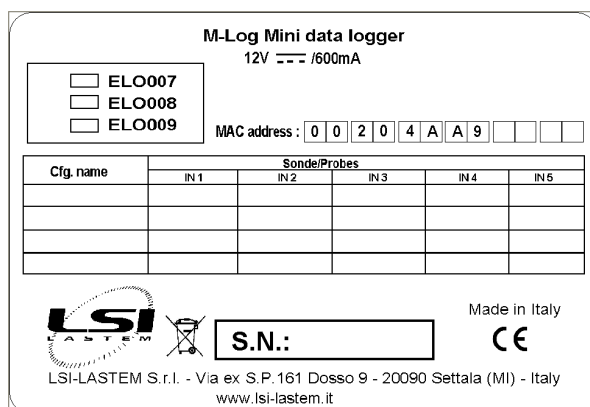

3.2 Models

All the M-Log models are equipped with alphanumeric display, keyboard and inner battery; their distinguishing properties are as follows: different model of inputs and presence of different communication devices.

Code	Power supply 12 Vdc	Connector inputs	Terminal board inputs	One serial port	Two serial ports	Ethernet output
ELO007	X	-	X	X	-	X
ELO008	X	-	X	-	X	-
ELO009	X	X	-	-	X	-
ELO011	X	-	X	-	X	-

- **ELO007**: terminal board inputs, one serial port and one Ethernet output;
- **ELO008**: terminal board inputs, two serial ports;
- **ELO009**: connector inputs, two serial ports;
- **ELO011**: reduced terminal board inputs, two serial ports.

3.3 Mechanical and electrical installation

M-Log is able to be used for both internal use (placed on a flat surface of fixed onto a wall) and external use (inside suitable protection boxes).

The use of supports furnished by LSI LASTEM is advisable for indoor applications:

BVA304	Universal tripod to support BVA311 stand
BVA311	Stand for support of n.5 probes and M-Log on tripod or on wall
BVA312	Stand for support of further n.5 probes and M-Log on BVA311 or on wall
BVA314	Sidebar for support of stand on the wall

3.3.1 Instrument power supply

M-Log is equipped with 1,95 A, lithium ion, internal rechargeable battery.

All models can be powered by an external power supply pack (8 ÷ 14 Vdc), by means of connector placed on top panel of instrument; in this case the positive pole is pole inside the connector. In any case pay attention not to invert the power supply polarity (although the instrument is protected from wrong procedure).

For ELO007 and ELO008 models is also possible to power by means of terminal board.

Make reference to table below for connection with instrument-input and sensors-output power-supply terminals or other devices that need power supply.

Connection	Terminal
0 Vdc battery	28 or 29
+ Vdc battery / + Vdc fixed to power sensors and external devices	30 or 31
GND	32

When there’s GND wire (grounding), it’s recommended to connect it with 32 terminal.

In case of no switch on of the device, push the RESET button (located on the higher panel of the instrument) and then try to push the keys combination for switch on; if the sensor is still off, send it for repair at LSI LASTEM.

WARNING: in case terminals 5-6 and 16-17 feed outside equipments, they must be equipped with power fail circuit against short circuits or absorbed currents above 1 A.

WARNING: in applications where there is LSI LASTEM *BSO103.1* sensor (CO₂ probe), M-Log datalogger **must** be powered by means of external power supply pack; the only M-Log internal battery isn’t able to supply enough power for right operation of connected sensor.

3.3.2 Internal rechargeable battery

The internal rechargeable battery ensures to the instrument the autonomy, the independence and the handiness during different applications that involve it; it is normally subject to unload. The low battery signalization occurs on datalogger through three times blinking of LED ■-Err (see §**Errore. L'origine riferimento non è stata trovata.**).

The total discharge of the battery will lose the date/time of the datalogger; this condition is very dangerous because it makes the stored data unreadable so also compromising the operation of data unloading and data storing on the acquisition system.

Note: It’s advisable to check the date/time displayed by the datalogger and eventually update to the current date/time through 3DOM software (see §4.5.2 of SWUM_00339 manual reported on LSI LASTEM products DVD MW6501):

- before starting the survey;
- before and after operations of battery recharge;
- after a long period of inactivity;
- when the message of low battery is displayed (see §**Errore. L'origine riferimento non è stata trovata.**).

3.3.3 Inputs and actuators

3.3.3.1 ELO007-ELO008-ELO009 models

The instrument is fitted with 4 analogue inputs in *differential* mode and 8 in *single-ended* mode (§3.3.4**Errore. L'origine riferimento non è stata trovata.**) (independent, for sampling of voltage signals, current, resistance, Pt100 with three or four wires, thermocouples), a digital input (for sampling of pulse inputs, frequency or digital state) and 2 actuators used to power the sensors connected to the terminal board; the actuators can also be used by the actuation programmable logics, than can produce alarms according to the values acquired by the sensors . The voltage available on these terminals depends on the kind of power supply received by the instrument.

Use the program *3DOM* (see SWUM_00339 available on LSI LASTEM product DVD – MW6501) to configure the operation to switch on the sensors by means of the switching powers. In order to choose the actuation time is advisable to consider both the energetic saving and the time the sensor needs to initialize.

The association between input and switching power is fixed, as shown in the table below. The number of the terminal is indicated in italics; we understand, for example, that inputs 1 and 2 both make use of the first actuator; therefore it cannot be used for the other inputs. In case of sensors that generate two signals (like the thermo-hygrometric sensor), it’s suitable to select both inputs that use the same actuator.

A third actuator is on the pin9 of the serial port connector 1 and it can be used for sensors that interface to M-Log with serial connection; if configured appropriately with a logic based on the power level or battery power level, it can be used as fixed power supply.

All the actuators can be activated manually by the diagnostic window type 4 (see §4.3.4).

The following tables show the terminals used to connect sensors and power supply for ELO007 and ELO008 models.

TERMINAL BOARD								
Analogue input	Signal				GND	Actuator		
	A	B	C	D		Number	+V	0 V
1	<i>1</i>	<i>2</i>	<i>3</i>	<i>4</i>	7	1	5	6
2	<i>17</i>	<i>18</i>	<i>19</i>	<i>20</i>				

3	8	9	10	11	23	2	21	22
4	24	25	26	27				

Digital input	Signal			GND
	E	F	G	
5	12	13	14	15 or 16

Actuator/Alarm output on the serial connector	
+V	0V
Pin 9	Pin 5

The following pictures explain in detail the connections of all types of sensors, both analogue and digital.

Sensors with analogue signal (in differential mode):

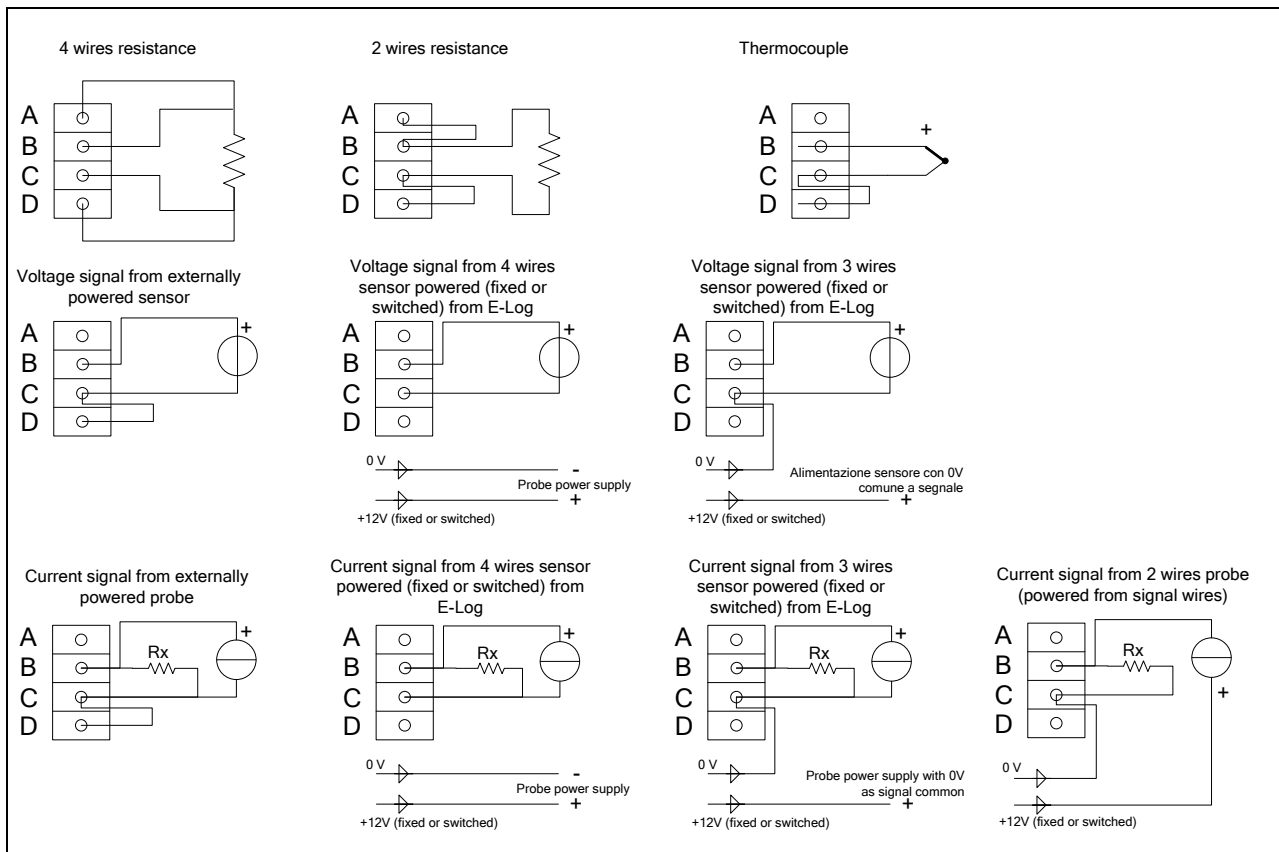

The drop resistance, indicated by Rx, is used to return a voltage signal from the current generated by the sensor. Program 3DOM supplies a library for the setting of the LSI LASTEM sensors, including some powered outputs; for such models the settings have been arranged to use the energized scale -300÷1200 mV, thus being able to use 50 Ω drop resistances.

Sensors with digital signal:

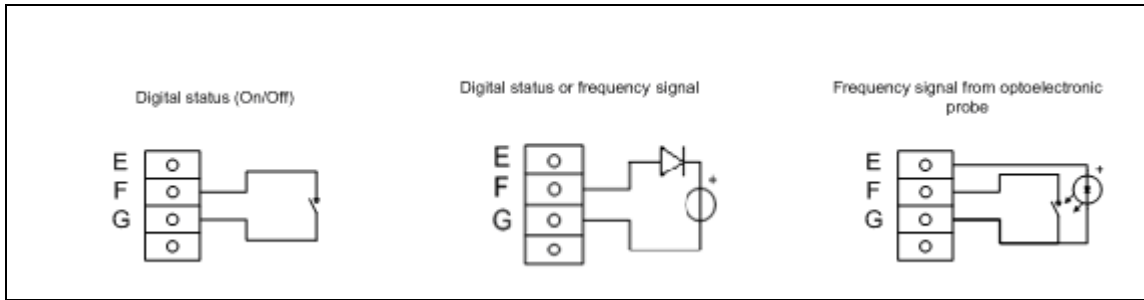

3.3.3.2 EL0011 model

The instrument is fitted with a digital input (for sampling of pulse inputs, frequency or digital state) and an actuator that switches the power supply on pin 9 of the serial port connector 1. The actuator can be used for sensors that interface to M-Log with serial connection; if configured appropriately with a logic based on the power level or battery power level, it can be used as fixed power supply by the connected device.

The following tables show the terminals used to connect sensors and power supply.

Digital input	Signal			GND
	E	F	G	
5	12	13	14	15 o 16

Actuator/Alarm output on the serial connector	
+V	0V
Pin 9	Pin 5

Sensori con segnale digitale:

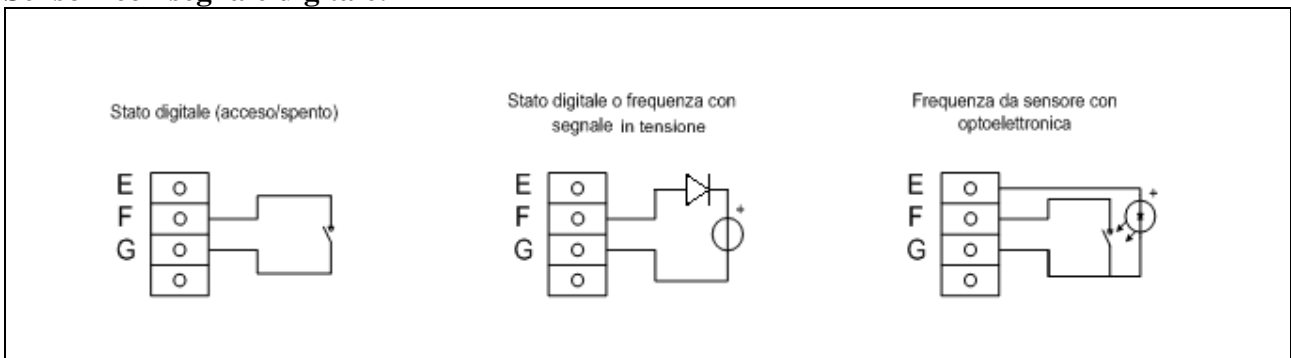

3.3.4 Single-ended inputs

Starting from datalogger firmware version 2.10.00 (model ELO11 excluded) it is possible to double the number of analogue inputs, passing from 4 to 8. This function is available only for sensors with current signals (this function is called single-ended). Resistive signals, instead, go on occupying a full single physical input (this function is called differential).

Differential inputs are more immune from electromagnetic disturbances than single-ended ones and, when possible, they have to be preferred.

All sensors generating current signals and all powered sensors can be connected to single-ended inputs (see connection scheme).

WARNING:

To R/M Log instruments it is possible to connect only: radiometers, thermo-couples, fluxmeters or signals externally powered (see connection scheme)

Sensors with analogue signal (single-ended mode):

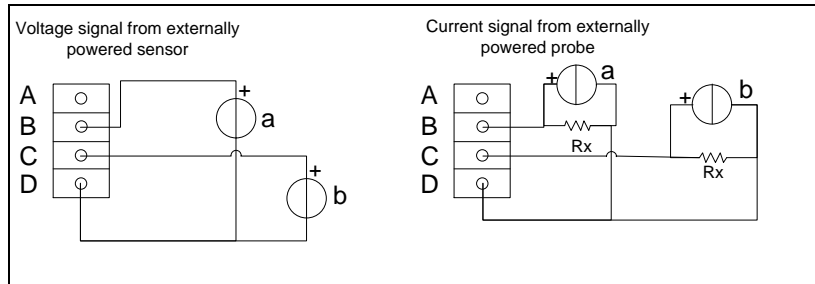

The drop resistance, indicated by Rx, is used to return a voltage signal from the current generated by the sensor. Program 3DOM supplies a library for the setting of the LSI LASTEM sensors, including some powered outputs; for such models the settings have been arranged to use the energized scale -300÷1200 mV, thus being able to use 50 Ω drop resistances.

When a probe is added using the 3DOM probes library, those sensors are always added in differential mode; for this reason is not possible add a single-ended probe to a configuration where there is only one single-ended sensor free; when this situation occurs set the measure parameters manually matching the single-ended probe needs; otherwise change, if possible, different measures from differential to single-ended mode until obtaining a complete differential input free (two single-ended sequential inputs).

3.3.5 Serial communication lines

All the M-Log dataloggers are equipped, on the upper panel, at least with one communication serial port (furnished with double connector, DTE and DCE; female if the datalogger is used as a DCE device, male if it is used as a DTE device); ELO008 and ELO009 have another communication serial port (only in DTE mode). Serial port are used to program the instrument's operative modes and data download, by means of the LSI CISS communication protocol.

The serial port leaves our factory with the following default configuration:

- Baud rate: 57600 bps;
- Data bit: 8;
- Stop bit: 1;
- Parity: none;
- Network address: 1.

The instrument can be programmed; however only the *baud rate* and *network address* can be changed; all other parameters cannot. The rate can be programmed from 1200 to 115200 bps; in case of use of phone modem GSM/GPRS it is suitable program 9600 bps on bound rate.

Electrically speaking, both ports are configured as a DCE device. The following table shows the meaning of each serial connectors' pin:

RS232 Serial port	Signal	Pin for DCE device	Pin for DTE device
	TD	2	3
	RD	3	2
	GND	5	5
	RTS	8	7
	CTS	7	8

3.3.6 Modem power supply

M-Log can power the modem continuatively (through 12 Vdc powering from the terminals, like shown at §3.3.1), or through timed actuator, in order to reduce the electric energy consumption of the system.

You must use actuator n.3 to power the modem through actuator. Activate it according to the different connected modem:

- GSM Modem: the actuator is started at time of instrument starting; in this case the telephone connection holds on also during the remote re-configuration of the instrument through *3DOM* program; the next shutdown happens by means of the timed actuation logic, according to the programmed shutdown time; i.e. in case of following programmed timed logic, starting at 15:00 o'clock and shutdown at 16:00 o'clock, if the instrument is started at 14:30, the effector will operate one hour and half;
- GPRS Modem: the actuator is started at time of instrument starting and the shutdown happens about one minute later; next modem activation will happens according to the GPRS data transmission timing, as programmed with *3DOM*.

3.4 Configuring the operative mode

The instrument supplied by LSI LASTEM is equipped with standard configuration that includes only the battery tension and the internal temperature; for models series ELO009 it's possible to set-up the configuration automatically, as they are equipped with function for sensors auto-recognition; but configuration of models ELO007, ELO008 and ELO011 must be set-up by means of *3DOM* software, through the direct input from software library or through support of suitable models designed for different user applications (microclimate, walls transmittance ...)

Both the measurements autogeneration and the applicative models produce the generation of only type "Ave" elaborations (mean value). When configuration is set-up starting from sensors in *3DOM* library, it's possible to obtain the generation of more complete processings ("Min/Ave/Max", "Tot", "Stdev", "%valid data" ...); so in this case it'll be possible to delete, manually, the elaboration you aren't interested in.

For all M-Log releases the modification of configuration, in order to obtain new setup satisfying with one’s own needs, is made through PC connected to serial communication port 1 with *3DOM* program; the serial port 2 (model ELO007 excluded) can be used for configuration upload only when it is configured to use CISS protocol.. For details about all settable parameters, make reference to online help of this program or user manual DVDs made by LSI LASTEM. For connection of serial line and its programming, see §**Errore. L'origine riferimento non è stata trovata.**

During the configuration data upload (by means of the *3DOM* program) the survey (in progress in the instrument) is closed, in order to allow to the instrument the right reconfiguration condition. At this point the measures list on the display (see §**Errore. L'origine riferimento non è stata trovata.**) is replaced with the notice “Survey halted”; it means that the survey has been halted.

Note: when programming a new configuration, all data stored in the instrument's memory will be deleted. For this reason we advise to receive on PC all data from the instrument before uploading the new configuration.

3.4.1 Language configuration

The instrument always uses English language for display messaging; for measurement texts it is factory programmed to use Italian names but this can be changed by *3DOM* configuration program.

4 Instrument use

4.1 Frontal panel overview

Picture below shows the frontal panel of the instrument:

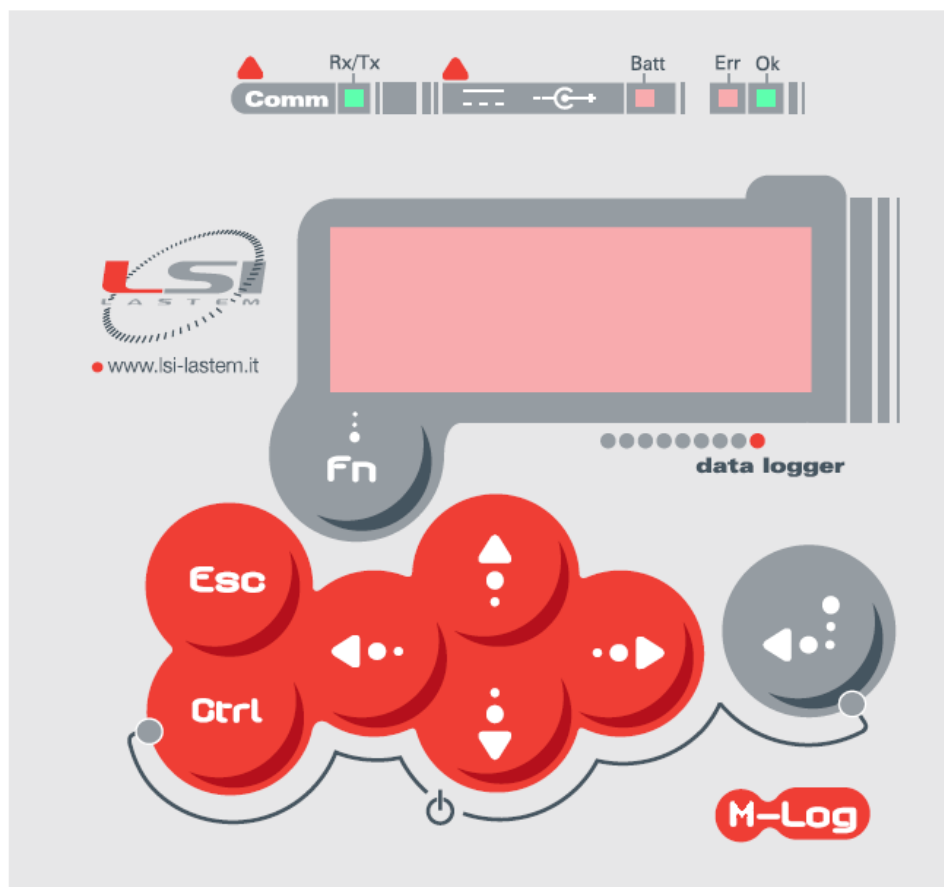

The top side of frontal panel houses the bright indicators (power supply, battery, transmission and reception, error signalling) and the display, that can be used for right operation of instrument and for display of data acquired by sensors in real time.







The bottom side of frontal panel houses the keyboard that includes function keys and arrow keys

4.2 Using the keyboard









The keyboard includes a series of four arrow keys and four function keys.

The following table summarizes the main functions of each key, contextually according to the state the instrument finds itself in.

While showing the values of the measures:

-  Goes to the diagnostic window Type 1
-  Changes the display mode of the measure name (extended, abbreviated), of the measure unit, the number of terminal which the sensor is physically connected to or ID/channel of radio sensor, alarms set and resistances of recognition (only for series models ELO009)
-  Changes the display mode of the measure name (extended, abbreviated), of the measure unit, the number of terminal which the sensor is physically connected to or ID/channel of radio sensor, alarms set and resistances of recognition (only for series models ELO009)
-  Scrolls up the measure list
-  Scrolls down the measure list
-  Holds/releases measure scrolling
-  Switches the display off and on

While showing diagnostic information:

-  Shifts to the display window of the values of the measures.
-  If applicable, pressed at the same time with  key, it resets display data (statistics, errors and other information).
-  In the display window of the communication statistics it shifts from serial 1 statistics to serial 2 and vice versa; in the type 5 diagnostic window it shows or hides the additional information about the GPRS modem (only LSI LASTEM technicians).
-  In the display window of the communication statistics it shifts from serial 1 statistics to serial 2 and vice versa; in the type 5 diagnostic window it shows or hides the additional information about the GPRS modem (only LSI LASTEM technicians).
-  Shows the previous diagnostic window.
-  Shows the next diagnostic window.
-  In the type 5 diagnostic window it switches on the GPRS modem (in case it’s switched off) and starts the data communication through GPRS; in the type 4 diagnostic window it powers on actuators; in the type 7 diagnostic window it powers on the radio of Slave instruments.
-  In the type 5 diagnostic window it resets GPRS modem.

4.3 Display informations and controls



Through the user interface of the instrument, is possible:



- Input of commands with immediate effect
- Display of:
 - Product presentation window;
 - Instantaneous values’ scrolling list of all programmed measures;
 - Diagnostic information.

4.3.1 Input of commands with immediate effect

M-Log  key gives the double function to key pressed with it contemporaneously.



4.3.1.1 Power on and power off the instrument



When the instrument is off, pressing  and  keys contemporaneously, the instrument turns on and shows the product presentation mask (see §**Errore. L'origine riferimento non è stata trovata.**) that will be displayed for about 10 seconds; when this mask disappears, the datalogger will start the survey according to the configuration saved before the shutdown.

When the instrument is on, pressing the same ( and ) keys, the instruments shows the mask below and will be awaiting for confirmation through  key before its definitive shutdown; at pressing of any other key the instrument will return to previous condition.

1	2	3	4	5	6	7	8	9	10	11	12	13	14	15	16	17	18	19	20
P	r	e	s	s		F	n		t	o		c	o	n	f	i	r	m	



4.3.1.2 Fast acquisition mode

Pressing  and  keys contemporaneously from instantaneous data display mask, it’s possible make sensors acquisition rate faster than rate set-up by configuration.

Pressing again  and  keys contemporaneously the acquisition rate will return to follow the configuration setup..

For more details see §5.2.5

4.3.1.3 Configuration with automatic recognition of probes

After physical connection of sensors, it’s possible configure the instrument (only for M-Log ELO009 model) with automatic recognition of probes pressing  and  key contemporaneously; M-Log will show following mask

1	2	3	4	5	6	7	8	9	10	11	12	13	14	15	16	17	18	19	20
P	r	e	s	s		E	n	t	e	r		t	o						
c	o	n	f	i	r	m		a	u	t	o	-	c	o	n	f	i	g	
W	A	R	N	!		S	t	o	r	e	d		e	l	a	b	.		
w	i	l	l		b	e		d	e	l	e	t	e	d	!				



and stay awaiting for confirmation through  key before you start the operations for auto-recognition of probes.

At the end of auto-configuration function, if the instrument hasn’t found any errors, a new survey will be started and new mask of instantaneous values will be displayed.



Warning: this operation will delete all stored data; before you confirm the auto-recognition, download the stored data on PC.

4.3.1.4 Record the starting and ending time of data acquisition (Survey n)



M-Log is a mono-survey instrument, but offers to the user the possibility to mark the time of surveys; in other words it allows to fix manually, for one survey, the starting and ending time of data acquisition. These information are shown by LSI LASTEM application programs (such as Microclima) in order to make easy the selection of data included into given period of sampling.

The starting time, to consider data, is fixed pressing  and  keys at the same time; display will show following mask:





1	2	3	4	5	6	7	8	9	10	11	12	13	14	15	16	17	18	19	20
			-	-		S	u	r	v	e	y		n		-	-			
1	T	e	m	p															
2	V	B	A	T	T														
3	e	c	c	.															

But pressing again  and  keys at the same time it’ll be fixed the ending time; the instrument will continue to save the data, but not inside survey closed before. An univocal numeric value *n* will identify the selected slot; *n* will be increased every time a new slot for acquired data consideration is fixed. The reset of survey number is made only modifying configuration from PC or starting new auto-recognition procedure.

4.3.1.5 Reset statistics

Pressing  and  keys at the same time, it’s possible to reset values of diagnostic mask statistics number 2 (see §4.3.4), in other words the values referred to communication (bytes and transferred and received messages).







4.3.1.6 Fast transmission mode

Pressing  and  keys at the same time from diagnostic window type 2, it’s possible select the sensor fast transmission mode (transmission every second). This function will be active **only** if a value different from 0 is set in the *Serial communication port x → Instantaneous values automatic transmission rate* option (x takes values 1 or 2 according to the relative serial port) in the configuration send to the instrument. The fast transmission mode will be activate only on the serial port that is interrogated during the display of diagnostic window type 2 relative to the serial port 1 (C1), the keys combination  and  will activate the fast transmission mode only for coomunication serial port 1.

Pressing again the same keys combination, the transmission mode will return to work according the configuration’s parameters.

4.3.1.7 System clock setting

A few seconds after being switched on, the instrument can require to re-set the clock (date and time). This can happen only in particular situations as, for example, the complete discharge of the battery: in this case the date/time setting is compulsory and cannot be cancelled. The date/time changing can anyway be performed whenever desired from the Diagnostic window type 1. Use the following keys:

-  : enter *change* mode; exit from *change* mode confirming and storing the new date/time;
-  : exit from *change* mode discharging possible modified values;
-   : move the cursor over the field to modify;
-  : it augments the value selected by the cursor; other elements of date/time can change contemporarily;
-  : it reduces the value selected by the cursor; other elements of date/time can change contemporarily.

4.3.2 Product presentation window

When the instrument is started, the following informations will appear on the display for a couple of seconds:

1	2	3	4	5	6	7	8	9	10	11	12	13	14	15	16	17	18	19	20
L	S	I	L	A	S	T	E	M							I	t	a	l	y
M	-	L	o	g	x	x	x				V	a	a	.	b	b	.	c	c
S	N		y	y	m	m	n	n	n	n	/	u	u	u	u	u	u	u	u

where:

- xxx: instrument model;
- aa.bb.cc: program release (higher.lower.build);
- yymmmnnn: serial number;
- uuuuuuuu: serial number or instrument number (settled by the user).

These informations are also available while the instrument is working and can be called by simply using the keyboard to select this window to be displayed.

4.3.3 Instantaneous values of measures

Each line displays the last value of a measure, be it acquired or calculated. The information is displayed as follows (one or more lines):

0	1	2	3	4	5	6	7	8	9	10	11	12	13	14	15	16	17	18	19
n	n	m	m	m	m	m	m	m	m	m	m	m	v	v	v	v	v	v	v

where:

- nn: ordinal number of the measure; it doesn’t indicate the physical input number;
- mmmm...: completed measure name; see §3.4.1 to change this text or the language used;
- vvvvvvv: value of measure; the error state is identified by the writing "Err"; the value is justified on the right.

Use navigation key  to display the abbreviated name of the measure, the measured value and its measure unit.

0	1	2	3	4	5	6	7	8	9	10	11	12	13	14	15	16	17	18	19
n	n	m	m	m	m	m	z	z	z	z	z	z	z	v	v	v	v	v	v

where:

- nn: ordinal number of the measure; it doesn’t indicate the physical input number;
- mmmmm: shortened measure name (5 characters);
- zzzzzzz: value of measure; the error state is identified by the writing "Err"; the value is justified on the right;
- vvvvvv: measure unit.

Pressing again  key you obtain the display with shortened name of measured quantity and number of input the sensors is connected; if the measurement has been calculated, instead of number of input it’s displayed sign “-“; if measurement has been acquired by serial port or radio, instead of number of input they’re shown Network Address of sensor (with prefix “A”), and number of its channel to which the measurement is referred (with prefix “C”).

In case the instrument has been programmed with one actuation logic at least, a further pressing of  key displays the alarm condition of measurement: sign “OK” shows that measurement hasn’t generated any alarm condition, at the opposite it’s displayed sign “Alarm”.

In this mask, in M-Log models of series ELO009, it’s also displayed value of resistance that has allowed the operation of auto-recognition of probe through datalogger.

0	1	2	3	4	5	6	7	8	9	10	11	12	13	14	15	16	17	18	19
n	n	m	m	m	m	m	z	z	z	z	u	u	R	R	v	v	v	v	v

where:

- nn: ordinal number of measurement; it doesn't specify number of physical input;
- mmmmm: shortened name of measurement (5 letters);
- zzzz: values that specify if measurement has been acquired directly (it'll be displayed letter "I"), calculated (it'll be displayed symbol "-"), acquired through radio (it'll be displayed letter "A" plus address and letter "C" plus number of channel to which it's associated);
- uu: value of physical input to which probe is connected;
- vvvvvv: value of recognition resistance.



keys allow to shift from one format to an other one.

4.3.4 Diagnostic information

Some diagnostic windows are used to display information about the operation of the instrument and the statistics; they are displayed by the pressing the  button from the window of *Instantaneous values of measure*. Diagnostic window type 1:

0	1	2	3	4	5	6	7	8	9	10	11	12	13	14	15	16	17	18	19
D	T		d	d	/	m	m	/	y	y		h	h	:	m	m	:	s	s
E	r	r		e	e	e	e	e	e	e	e								
M	e	m		m	m	m	m	k	B		F	r	e	e	w	w	w	%	
M	s	r		A	a	a		S	s	s		C	c	c					

where:

- dd/mm/yy hh:mm:ss: current date/time of the system;
- eeee...: numeric code, expressed in hexadecimal number, which corresponds to the 32 bits of the error window of the system; in order to decode this error, go to §**Errore. L'origine riferimento non è stata trovata.**;
- mmmm...: data memory capacity in kByte;
- www: percentage of available memory; M-Log has circular storage and for this reason the memory is virtually end-less. The calculation of availability is made according to total memory space dedicated to elaborated data in comparison with data already transferred to PC from serial line; during the reading of elaborated data this value is updated continuously in order to specify the percentage of available memory in relation to datum is being read from one instant to the next; if the instrument shows that percentage value is zero, it means that circular storage algorithm has stored new data and deleted the older ones.
- aa: number of measures acquired by the inputs of the instrument;
- ss: number of acquired measures from serial port;
- cc: number of calculated measures.





By pressing the arrow  you can see the old camp which is the number in exadecimal notation that expresses the value of the position in writing in the memory of the elaborated data (with a

starting value which is equal to 0); when using a 2 MB memory, this value is expanded to 1FFF; the unitary increment of this value indicates a 256 byte consumption.

Use key  to shift to diagnostic window type 2:

0	1	2	3	4	5	6	7	8	9	10	11	12	13	14	15	16	17	18	19
R	e	s	e	t		d	d	/	m	m	/	y	y		h	h	:	m	m
C	n		B	y	t	e						M	s	g					
R	x		a	a	a	a	a	a	a	a		b	b	b	b	b	b	b	b
T	x		c	c	c	c	c	c	c	c		d	d	d	d	d	d	d	d

where:

- dd/mm/yy hh:mm: date/time the statistic was last reset; resetting the statistical values can take place locally, (by pressing at the same time of  and  keys) or remotely through a suitable PC command;
- n: number of the instrument's serial port; go to the following line with  key;
- aaaaaaaaa: number of bytes received;
- bbbbbbbb: number of messages received;
- cccccccc: number of bytes transmitted;
- dddddddd: number of messages transmitted;

This mask is very important for diagnostic reasons, in order to value the quality of communication among M-Log datalogger (configured in master-slave mode) and between M-Log and PC.

Communication between PC and M-Log

Every standard message consists of about 13 characters; so:

In case of reception of more than 13 Rx characters and no increase of Rx of Msg value	M-Log bit rate could be higher than rate set on PC
In case of reception of less than 13 Rx characters and no increase of Rx of Msg value	M-Log bit rate could be lower than rate set on PC
In case of rates set correctly, right reception of characters but not decoded message (Msg value doesn't increase)	Could have been used different protocols or could be communication electric problems (i.e. on 485 line, + and - could have been inverted) or communication line is too jammed.
In case of: rates set correctly, right reception of characters, encoded message but no answer (Tx of Msg value doesn't increase)	The addressee of message isn't stated M-Log but an other datalogger: check network address (Protocol ID)

Communication among M-Log datalogger

The correct datalogger communication can be checked displaying that the following fields are increased the same value with similar timing:



- Byte and Msg fields of Tx for communication serial port of slave datalogger;
- Byte and Msg fields of Rx for communication serial port of master datalogger.



Use  key to shift to diagnostic window type 3:

0	1	2	3	4	5	6	7	8	9	10	11	12	13	14	15	16	17	18	19
C	1		A	d	d	r	x	x	x	>	y	y	y	y	y	y	b	p	s
C	2		A	d	d	r	x	x	x		y	y	y	y	y	y	b	p	s

where:

- xxx: network address of the instrument;
- yyyyy: communication rate (bit rate) of the serial port.

The character “>” shows the current serial port; for this port are valid the modification commands of the bit rate (from 1200 to 115200 bps), using the keys   on instrument; this modify is possible only for serial port number 1. M-Log serial port are standard set to 57600 bps.

By pressing key  and  the instrument will set the network address temporarily to value 1 and will carry out, after some seconds, at least one test transmission of the instantaneous values that can be checked by means of any program for terminal emulation for diagnostic purposes.



Note: the communication values can be changed by means of keyboard but this is a transitory modify, because it’s arranged to solve quickly possible communication problems with the outside equipments; in fact every time the instrument is switched on again it uses the PC’s programmed configurations. Use 3DOM program to program these setups definitively.

Use  key to shift to diagnostic window type 4:

0	1	2	3	4	5	6	7	8	9	10	11	12	13	14	15	16	17	18	19
O	U	T		1	2	3													
				x	x	x													
				^															
B	a	t	t.	:		y	.	y	V	(z	z	z		%)			

where:



- x: value of the single actuation output: 0 = output is inactive, 1 = output is active; the model ELO011 has only the output 3;
- y.y: value of the power supply-voltage measured by the instrument (Volt)
- ^ indicates the selected actuator;
- zzz: percentage value of power battery of the instrument. When the datalogger is externally powered displays a value below 100% (60% typically) even when the battery is fully charged (can be determined by switching off the charging LED on the frontal panel); removing the external power supply the value of battery is shown correctly. This feature is similar when “battery voltage” is a sampling measure.

For diagnostic uses, use the   keys to shift on the selected actuator (indicated by ^ symbol) and  key to shift from switched on to switched off modes and viceversa .

From 2.3 firmware version it is possible to force the actuator state among to the internal logics that could change (actuators logics or sensor power supply logics); in addition to the 0 value (actuator off) and 1 value (actuator on) is shown the F letter, one for each actuator, if the forcing is active. In practice, if the forcing is also imposed to an actuator state (that can assume 0 or 1 value) means that actuator will never be change by any internal logic (except the commands received from remote through CISS communication protocol or Modbus that have priority on F status); if the F forcing is off, the internal logic can normally change the actuator status. The diagnostic window is so displayed:

0	1	2	3	4	5	6	7	8	9	10	11	12	13	14	15	16	17	18	19
				f	f	f													
				x	x	x													
O	u	t		^	2	3													
B	a	t	t.	:		y	.	y	V	(x	x	x		%)			

where:

- ^ indicates the selected actuator; it is displayed on the *Out* line instead of the actuator number;
- f indicates the forced/fixed state of the actuator; it is activated pressing the  button; use the keys   to shift on the selected actuator; it can be assume the F value if the forcing is active or it isn't displayed if the actuator follows the programmed actuation logics.

Use  key to shift to diagnostic window type 5 (this window appears only if the configuration is provided to GPRS):

0	1	2	3	4	5	6	7	8	9	10	11	12	13	14	15	16	17	18	19
G	S	M	:	M		G	P	R	S	:	P								
C	S	Q	:	c	c		E	r	r	:	e	e							
C	o	n	n	.	:	n	/	t											

where:

- m: Status of connection to GSM network (0 “not connected”, 1 “connected”);
- p: Status of connection through GPRS protocol (0 “not connected”, 1 “connected”);
- cc: quality of GSM signal (0 “no signal”, 31 “top signal”); the value lower than 15 doesn't allow the GPRS use;
- ee: code of GPRS connection failure (0 “no error”);
- n: number of right connections (from last statistics reset);
- t: number of total connections (from last statistics reset).

In order to safeguard the modem memory the statistic is saved every 20 connection attempts and only if modem isn't powered through actuator.

For further details about the understanding of these window's data see §5.6.3

4.3.5 Shutting off the display

Shut off the display allows to save about 25 mW. It is therefore important to keep the display shut off whenever possible when the instrument is running on batteries with or without sun panels.

To shut off the display you can use the keyboard (see §4.2) or use program *3DOM* to have it shut off; to do so, modify parameter "Characteristics – auto display shut off". By setting this parameter to *Yes*, M-Log will shut off the display after the keyboard remains inactive for three minutes.

4.4 Reset button

On the bottom panel, together with inputs for sensors (with terminal board or mini-din connectors), there's an hole for access to *Reset* key; the latter is only accessible through a pointed object (such as a straightened paper clip) and allows to instrument the reset of its possible block condition. Inside memory will remain the instrument configuration, processed data and date and hour of system; on the contrary all statistics will be reset.

4.5 LED's

On frontal panel of M-Log there are four bright indicators (LED) that display the operation state of instrument (OK/ERR), the communication from and to external devices (Rx/Tx) and the charge-condition of inner battery.



See below a detailed description of each state.

Status indicator (Err, Ok)	Communication indicator (Rx/Tx)	Battery (Batt)	Description
Off	-	-	Instrument switched off, or low feeding voltage (min. 3,5 Vcc)
Single quick (5 s) green blinking	-	-	Instrument switched on. Regular operation (acquisition mode)
Three quick green blinkings	-	-	Instrument switched on. The instrument operates in reconfiguration mode
Five quick green blinkings	-	-	The instrument is on. The instrument operates in quick acquisition mode
Red slow blinking	-	-	Instrument switched on. An error occurred. The number of blinkings indicates the type of error (see § Errore. L'origine riferimento non è stata trovata.)
-	Off	-	No current communication

-	Blinking	-	Instrument is receiving data from the serial communication lines or from radio
-	-	Switched off	Instrument feed from external; battery is fully charged
-	-	Switched on	Battery is charging

Interval between blinking cycles: 5 s.

Quick blinking period: 125 ms

Slow blinking period: 375 ms.

5 M-Log additional features

M-Log is an instrument designed to acquire, elaborate and store measures from sensors connected to its analogue, digital and serial inputs. On the base of the acquired data it can operate field actuations according to the programmable algorithms.

5.1 Starting and running the survey

Note: The first operation to do after turning on the instrument is to check the date and time displayed by the datalogger; in case of disagreement with the current date and time, update them (see §**Errore. L'origine riferimento non è stata trovata.**).

M-Log performs the measurements and processings as they always belong to only one survey. The execution of survey is made in automatic way, few seconds after the starting of instrument.

The features of datalogger configuration can be changed through software 3DOM; after a configuration change and its transmission to the instrument, all data in the memory will be automatically deleted and a new survey will start. The data management is allowed by application software on the PC.

5.1.1 Automatic recognition of probes

M-Log dataloggers complete with inputs with mini-din connectors (series ELO009) are equipped with function for auto-recognition of probes made by LSI LASTEM.

The inner library of M-Log allows the instrument its auto-configuration according to LSI LASTEM sensors physically connected to datalogger (for its operation see §4.3.1.3); the library assigns the respective measurements (acquired and calculated) to each specific recognized sensor and in this way it automatically setup the configuration with more suitable parameters.

The measurements configured in this library (programmed thanks to experience of LSI LASTEM engineers) have acquisition times and other management modes in accordance with type of measured quantity. It's however possible to modify the configuration parameters (processing time, acquisition rate, name of the measurement ...); in order to carry-out this modification, follow the instruction below:

- 1- open 3DOM software;
- 2- download configuration from instrument (see §4.4.8 of SWUM_00339 manual);
- 3- modify the interesting parameters (see §4.4 of SWUM_00339 manual);
- 4- save the configuration and re-send it to instrument (see §4.4.7 of SWUM_00339 manual).

The programming of new configuration produces the erasing of all data in the instrument memory; for this reason it's recommended to transfer data on PC, through same program, before you setup new configuration.

In order to allow the instrument the right acquisition, the acquisition rates of measurements must be lower or equal to elaborated rate. During auto-configuration function, one or more measurements, having acquisition rate higher than rate setup for processing, can be generated in M-Log; to avoid this possible error, M-Log has been equipped with function of automatic correction that restores the acquisition rates (if they are higher) equal to elaborated rates automatically.

During auto-recognition function could be pointed out some errors; here below the codes and their relevant meanings:

1	GR_CISS_Error	In the instrument the library of sensors includes the description of sensor or non-valid measurement
2	GR_EmptyLibrary	The instrument doesn't include a valid library of sensors
3	GR_ParamNotFound	The measurement doesn't include the placeholder for demanded parameter
4	GR_UndefinedProbe	The connected sensor hasn't been defined in library of instrument
5	GR_UndefinedMeasure	The connected sensor generates a measurement that hasn't been defined in library of instrument
6	GR_DepMeasureNotFound	One calculated measurement requires one dependent measurement (acquired or calculated by same or other sensors) that hasn't been generated
7	GR_DepMeasureMarkerNotFound	The tag for dependent measurements, included into measurement definition, hasn't been found
8	GR_MeasureUpdateRateNotFound	The tag for the update rate, included into measurement definition, hasn't been found
9	GR_SensorCalibrMarkerNotFound	The tag for calibration value, included into measurement definition, hasn't been found
10	GR_UndefinedProbeCalibrParam	One connected sensor requires the definition of calibration value that hasn't been defined in standard quantities (*)
11	GR_UpdateActiveConfigError	Memory writing error during update of instrument current configuration

(*)Algorithm for search of parameters for sensor calibration: if there's only one defined parameter it's always used for every input (also more than one); if there're several defined parameters, they must correspond with specified input; in other cases, error. The calibration parameters can be defined at the end of list of standard quantities.

The function of probes auto-recognition is a local setup, in other words the configuration is set-up automatically and just in the instrument where this function is required. In case there's a network of M-Log dataloggers, it's necessary the use of 3DOM software in order to update the configuration of master instrument and acquire properly all quantities coming from other acquirers by radio.

5.1.2 Checking the power supply voltage

During the survey the instrument checks the power supply voltage constantly, in order to grant its enough to the inner functions. The check isn't arranged to grant the operation of the outside devices (modem, sensors that need power supply, etc.) that already couldn't work regularly.

The check happens every minute: the instrument acquires and checks the power supply voltage; it must be 3,5 Vdc at least. In case it isn't enough, M-Log closes the survey in progress and stands by. During the stand-by it checks every minute the power supply voltage, until it'll reach the minimum value of 3,7 Vdc. The note "Power low" (instead of the measures list) shows the stand by condition looking forward the right power supply. When the right voltage comes back, the survey's re-opened and the standard operating modes re-start.

Note: the power supply voltage is acquired and checked, even if the instrument's configuration doesn't include (among the programmed measures) the corresponding acquisition measure of the battery's voltage. In order to store the feeding values (surveyed during the survey), the battery voltage measure must be programmed (like proposed by *3DOM* warning message).

5.2 Acquisition and calculation of measures

It is possible to acquire measures of sensors with a rate from 1 second to 12 hours; this allows a better representation of both fast-changing quantities (wind speed), as well as slow-changing ones (air temperature). It is possible to acquire as many as 10 measures per second.

For sensors which have to be powered, M-Log is fitted with own outputs with switched power supply (*actuators*).

The instrument is able to calculate quantities deriving from measures that sample the signs from the inputs: M-Log is fitted with a calculation library dedicated to environmental applications, also able to carry out useful mathematical functions (see §**Errore. L'origine riferimento non è stata trovata.**). M-Log is able to acquire and calculate up to a maximum of 50 total measures. Furthermore it's possible to program some calculated measures according to the data generated by other calculated measures.

Program *3DOM* can be used to program the measure sampling sequence: the program interface allows choosing the sequence in which the measures are displayed; hence which is the sampling sequence taking place during the survey. With *3DOM* you can also set automatically the measure sequence according to their acquisition rate (from the shortest to the slowest). This is important to gather measures which, during the acquisition process, must be sampled within the shortest intervals possible among each other (if they are allocated to only one actuator).

If configured with the same acquisition rate, the analogue channels following the first one will be sampled about 80 ms after the previous channel. This means that as many as eight analogue channels are sampled within a total time of 400 ms. Digital channels are instead sampled in about a flash. In case of application with a sensor with two measures that requires an actuator, remember that the probe must be connected on 1-2 inputs (actuator n.1) or on 3-4 inputs (actuator n.2).

5.2.1 Acquisition from sensors with serial or radio output

M-Log is able to acquire measures from sensors connected through serial port; both serial ports (if they are present) are enabled for this function although it is preferable and advisable to use the serial port 2 for this application. M-Log actually supports LSI LASTEM CISS protocol (owner communication protocol designed by LSI LASTEM and available in all sensors with microprocessor; device for via radio reception by means of LSI LASTEM DEC301 outside receiver).

The use of CISS protocol allows the connection to one or more LSI LASTEM sensors (even if they have different model); every configured sensor must have an univocal network address as regards other sensors connected on the same communication line. The connected sensors’ quantity determines the sampling minimum slot of the instrument: consider usually 3 sensors per second (the minimum acquisition time with 20 sensors must be set up 7 seconds at least). It is important that the acquisition time programmed in the instrument through *3DOM* application (shown by the parameter “*Update rate*”) must be the same of the spontaneous communication rate programmed by the sensor through *LSM* program.

The sensor can be programmed to repeat the message communication several times, in order to improve M-Log reception reliability; one repeat is usually enough (so the message has been transferred twice); before the arrangement of several repeats, take into consideration: the power autonomy of the sensor (if it is powered on through battery), and the further generated traffic. This can make worse the reception reliability (depending on the connected sensors and the programmed acquisition slots).

The acquisition of messages from the sensors happens as follow: *3DOM* application programs one measure for each quantity that has been acquired and transferred inside the message by the sensor; every measure is correlate to the respective sensor’s quantity by means of the sensor’s network address, that specify: the origin sensor (in *3DOM* it’s the parameter *Probe ID*), and the ordinal number of the quantity inside the message; for example in case of LSI LASTEM mod. DME811 sensor (programmed by network ID = 5) can be programmed up to 5 different measures, which correspond to the quantity: *air temperature*, *relative humidity*, *surface temperature*, *temperature*, *temperature*. The quantities number and their programming order aren’t binding (for example it’s possible program *surface temperature*, *relative humidity*), but the quantities sequence must have the same order like in the message; in the previous example two M-Log measures must be programmed as follow:

<i>Quantity</i>	<i>Network address</i>	<i>Measure index</i>
Surface temperature	5	3
Relative humidity	5	2

3DOM application automates some configuration operations by means of its sensors library: for example to program the LSI LASTEM mod. DME810 sensor press key *Add* from the measures list window and then select the relevant code from the available sensors list: the application knows that sensor is serial type and so it requires the sensor’s network ID; in succession the procedure generates all needed measures for the sampling of the sensor in the right way.

5.2.2 Acquisition from thermocouples

This feature is not available for the model ELO011.

M-Log is able to acquire the signals from many types of thermocouples. M-Log uses the internal temperature value as reference of value of the cold junction.

In these cases it is necessary to program, by means of the *3DOM* program, the measure of the internal temperature. The measure of the internal temperature must precede, in the measure sequence, all measures of quantities which use such reference.

5.2.3 Details about the measure acquisition process

The sampling of the signals produced by the sensors connected to the instrument's terminal board takes place according to the following logical procedure:

- 1) Measurement of the electrical signal based on its type (voltage, resistance, frequency, etc.) and its digital conversion into a 16-bit numeric value; the physical type of the sensor is programmed through parameter *Electrical measure type*;
- 2) Data validation: during this operation the value is limited within the scale values allowed by the physical type of measure;
- 3) Possible thermocouple value correction through the measure of the cold junction temperature (internal temperature of the instrument);
- 4) Linearization of non linear signals based on the setting of parameter *Linearization type*; the linearization may also take place through the setting of a polynomial function whose factors are specified until 10° degree (section *Linear parameter* of *3DOM*);
- 5) Recalculation of the value according to numeric parameters defined in section *Parameters*:
 - Computation of the measured quantity through the defined initial and final scale values;
 - Application of the calibration factor of the specific used sensor (radiometers, rain gauges, etc.);
 - Selection of the logical state with reference to the analogue signal thresholds;
 - Measure validation after processing accompanied by error signalization if greater (by 0.5%) than the limits set in output; wind direction and relative humidity are excluded;
 - Linearized quantity control: the instrument produces null output when receiving null input;
 - User scale limits.

All above parameters are indicated in section *Measure properties* in the measure modification window of program *3DOM*.

5.2.4 Acquisition from status signals

M-Log is able to acquire different types of digital status; they have to be configured for their connection to input number 5.

There are 3 different signal types: frequency signals, digital status and counters.

The default configuration of datalogger has been made for:



give logical status = 1	In case of short circuit or 0 V
give logical status = 0	In case of opened contact or 4 V

The sensors with status output that produce voltage (i.e. they aren’t pure contacts “open/closed”) but with variable voltage according to measured status, can be connected to M-Log through one diode; in this way every connection is always the right one, apart from the output voltage (no divider is required). The anode of diode must be placed on clamp F of terminal board’s entrance and the cathode towards the sensor.

For long acquisition it’s advisable power on externally the datalogger.



5.2.5 Fast acquisition mode of the measures

For diagnostic purposes, M-Log is equipped with a function that allows the acquisition of all sensors connected to its inputs at maximum speed (excluding the sensors connected to the serial port or received through the radio).

In order to activate the fast acquisition mode press key  and  at the same time. In this mode, the acquisition rate becomes 1 second every 10 measures and LED of the instrument will show a particular flashing: 5 green quickly blinkings.

Please note that in this condition the instrument:

- Acquires all sensors and recalculates all measures with minimum rate of 1 second every 10 measures;
- Keeps switching powers used to power the sensors permanently on;
- Uses up much more energy;
- Produces elaborations at the programmed rate; uses a higher number of samples compared to the normal conditions;
- In this mode the green *Ok* LED blinks 5 times every 5 seconds.

In order to set the instrument back to its normal mode, switch it off and on again without however pressing key  and  at the same time.

5.2.6 Activation of sensor control

Function valid only for M-Log with connectors (ELO009 model)

The instrument acquires the sensors rapidly thus using up little energy; hence increasing its operative autonomy.

When enabled, this function will replace the normal acquisition process. Avoid setting a check that is too frequent, especially in case of several fast rate measures. Do not use this function if you aim at saving as much energy as possible. For example, in case you have programmed 8 measures with 10 seconds acquisition rate, set the Probe check rate to 1 minute or higher.

5.2.7 Details about calculated measures

If the instrument has been programmed to process one or more calculated measures, the logical process will be the following:

- 1) Acquisition of all primary measures that allow the estimate of calculated measures; a calculated measure can be a primary measure for new calculated measure;
- 2) Collection of the value of primary measures; if at least one of these values is found to be in error, its calculated measure will also be indicated in error;
- 3) Collection of the value of standard parameters, whenever used in the calculation; the value of these parameters is decided during the configuration process and cannot therefore be modified during the survey;
- 4) Execution of the estimate;
- 5) Allocation of the calculated value to the measure's instant datum.

The acquisition rate of a specific calculated measure is set by *3DOM* so that it may correspond to the acquisition rate smaller than the calculated measures it depends on.

5.3 Measure elaboration

For each acquired or calculated measure it is possible to obtain statistical elaborations at a time base from 1 second to 12 hours. The selected elaboration base is common to all quantities.

Just as with the acquisition process (see §**Errore. L'origine riferimento non è stata trovata.**), the elaboration process, too, evaluates the time of the built-in clock as a multiple of the elaboration rate in order to determine the moment in which the elaboration of the statistical data begins. For example, if the elaboration rate were to be set to 1 hour and 30 minutes, and the current time were 15:24:01, the following elaborations would take place at 16:30:00, 18:00:00, 19:30:00, etc.; the elaboration uses all instant data acquired or calculated in the chosen elaboration span.

The available statistical elaborations are:

- Arithmetical calculations
 - Instantaneous value
 - Mean
 - Minimum
 - Maximum
 - Standard deviation
 - Total
 - % valid data
- Vectorial calculations specific for anemometric quantities
 - Prevailing direction
 - Resulting direction
 - Resulting speed
 - Direction standard deviation (sigma-teta)
 - Calm wind percentage

It is not possible to combine arithmetical and vectorial calculations for each specific measure.

Program *3DOM* can be used to program the elaboration parameters.

The instrument doesn’t have infinite process capacity: it depends on the number of acquired and calculated measures, on programmed actuation algorithms, on processings configured for each measure, and on continuous communications between the instruments and the outside devices; all these parameters cannot be programmed at the same time up to their available maximum, because the instrument could have wrong operation. The instrument has right operation in the following heavy duty condition:

- All analogue and digital inputs configured with measures of resistance, tension, state and frequency (4 kHz); every input sampled with 1 second rate;
- Six measures configured like measures calculated with several algorithms;
- The remaining measures (up to 50 measures) sampled by LSI CISS sensors with transmission every 10 seconds;
- Each measure is elaborated every 30 seconds with minimum, medium and maximum value statistics and standard deviation;
- All 10 active actuation logics configured with different algorithms and by the use of acquired and calculated measures;
- Serial communication constantly activated on both communication ports at maximum bit rate.

It’s possible to *relax* some parameters in this configuration (for example the measures total number or the active actuation logics number) in order to obtain best performances in other cases (for example the measures activation slot)

5.3.1 Vectorial calculation specific for anemometric quantities

Average direction (prevailing)

$$D_m = \text{gra}(\text{atan2}(\Sigma \text{Sin}(\text{rad}(\text{Dir})), \Sigma \text{Cos}(\text{rad}(\text{Dir}))))$$

Resulting average direction

$$D_{mr} = \text{gra}(\text{atan2}(\Sigma(\text{Sin}(\text{rad}(\text{Dir})) \cdot \text{Vel}), \Sigma(\text{Cos}(\text{rad}(\text{Dir})) \cdot \text{Vel})))$$

Resulting average speed

$$V_{mr} = \frac{\sqrt{(\Sigma \text{Sin}(\text{rad}(\text{Dir})) \cdot \text{Vel})^2 + (\Sigma \text{Cos}(\text{rad}(\text{Dir})) \cdot \text{Vel})^2}}{n}$$

Direction’s standard deviation (sigma theta)

$$\text{DevStandDir} = \text{gra} \left(\text{asin} \left(\sqrt{1 - \frac{(\Sigma \text{Sin}(\text{rad}(\text{Dir})) \cdot \text{Vel})^2 + (\Sigma \text{Cos}(\text{rad}(\text{Dir})) \cdot \text{Vel})^2}{n^2}} \right) \right)$$

Calm Percentage

$$\text{Calm} = \frac{\sum_1^n \text{Calm}}{n} * 100$$

Where:

Dir = instantaneous value of wind direction (0 - 360 °)

Vel = instantaneous value of wind velocity (m/s)

gra = conversion of an angle from radians to degrees

rad = conversion of an angle from degrees to radians

Calm = 0 in case of not calm wind velocity (< 0.3 m/s), otherwise 1

n = number of considered valid original data (no error)

5.4 Storing elaborated data

M-Log stores the calculated statistical processings (elaborated data) in the 2-MB internal memory; a part of this memory (128 kB) is used for configuration information and other internal information; the real capacity is therefore slightly less than the total storage capacity.

Data storage takes place circularly; once the memory is full, the new data will replace old ones.

By sending a new configuration to the instrument, all data so far stored will be cancelled; this happens because the new configuration information might be potentially not in tune with them, and the PC might misinterpret them.

The instrument stores the data in the internal memory only when a *data page* is full; the dimension of this page equals to 256 bytes; therefore the instrument might store the data only after several sequences of elaboration; this depends on the programmed elaboration rate, on the number of active measures and, for each one of them, on the selected elaboration elements. Please note that by switching off the instrument, some elaborated data inside the *data page* and those not definitely stored might be lost; for this reason we advise transferring the elaborations which have not yet been transmitted to the PC before switching off M-Log.

5.4.1 Memory autonomy

Depending on the chosen configuration (measures, types of elaboration for each measure and acquisition rate) the instrument will work somewhat autonomously as far as the maximum storage time is concerned, without replacing old data with new ones. The calculation of the time dimension of the maximum number of storable data is as follows:

$$A = K / (86400 / RE * NE)$$

where:

A = number of days of autonomy of the data memory;

K = value subordinate on the size of the used memory; for the 2 MB internal memory, K=386048;

RE = elaboration rate expressed in seconds;

NE = total number of elaboration’s elements programmed for all measures.

Note: the duration of memory measured in days (according with the current configuration) is displayed on PC after sending the configuration through 3DOM software.

5.5 Actuation logics

M-Log has got an actuation logics library. It’s useful to switch-on all type devices (alarms, solenoid valves, motors) according the surveyed parameters in surrounding environment. The actuation logics are based on the instantaneous value of the acquired and calculated measures. They can be programmed up to 10 calculation algorithms, that use same or different logics. One or more algorithms can be combined in two differed modes , in order to switch-on the selected actuator:

- 1) All algorithms must be in alarm at the same time (AND logic);
- 2) One algorithm can be in alarm at least (OR logic).

The actuator’s switch-on logic can operate according to *low power consumption* mode (the actuator is usually deactivated, and starts in case of alarm), or according to *safety* mode (the actuator is usually activated, and it shuts-down in case of alarm). Summarizing explanation in the table below.

<i>Operating logic</i>	<i>State</i>	<i>Actuator</i>
Low consumption mode	No alarm	Actuation output switched-off
	Alarm	Actuation output switched-on
Safety mode	No alarm	Actuation output switched-on
	Alarm	Actuation output switched-off

In case of one or several measures’ error (for example owing to sensor breaking, no-scale acquisition, or disconnected cable) it doesn’t modify the present state of the actuator piloted by the logic that uses the same measures.

The manual activation and deactivation of the actuators, performed by the user directly on the instrument from *Diagnostic window type 4* (see §4.3.4), does not affect the actuation logics. The actuation logic deactivates the actuator only if it has previously activated from the logic itself.

The actuation logic begins operation after the first activation of the actuator, even if this occurs temporally after the deactivation.

The programming of the actuation logics happen by means of the *3DOM* program according to two different phases:

- 1) Selection of the logics and their calculation parameters (section *Logics*);
- 2) Selection of the actuation outputs and their AND or OR modes correlation with the present logics (section *Actuators*); note that the same logic can be combined with other different logics several times, in order to switch over different actuators.

For M-Log with connector inputs (ELO009 series) may only be used the following actuation logics:

- Cyclic timer or with data/hour start/stop;
- Threshold value compare.

For M-Log with terminal board inputs (ELO007 and ELO008 series) may be used all the actuation logics available from 3DOM software.

The model ELO011 has only the actuator 3 on the serial line 1.

5.5.1 Eolic alarm

(Logic used only for M-Log with terminal board inputs – ELO007 and ELO008 series.)

The logic uses a wind direction measure to establish the condition of a wind position in a specified sector for a predefined time. Can be set:

- The measure that samples wind direction (degrees);
- The starting angle (extreme included) of the direction sector;
- The ending angle (extreme included) of the direction sector;
- The continuous permanence time of the wind direction inside the defined sector in order to detect the alarm condition;
- The continuous permanence time of the wind direction outside the defined sector in order to detect the end of the alarm condition.

Both times can be set from 0 seconds to 12 hours; if both times are set to zero, the wind direction in or out conditions inside the sector are immediately detected.

It is possible to join this logic with an another logic of threshold bypass type (see §**Errore. L'origine riferimento non è stata trovata.**) applied to a wind speed measure: in this way it's possible to refine further the alarm activation (i.e. to activate the alarm when the wind is more than 5 m/s for at least 3 minutes and inside the *Est* sector of 45 degree for at least 1 minute).

5.5.2 Evaporimeter filling

(Logic used only for M-Log with terminal board inputs – ELO007, ELO008 and ELO011 series)

The logic uses a water level probe inside the evaporimeter to establish the need for filling up it.

Can be set:

- The measure that samples the water level;
- The filling-up start time (it's recommended the automatic filling-up programmed in the morning, before the sunrise, in order to avoid temperature changing that could alter the evaporation measure);
- The maximum filling-up time, useful to avoid flooding in case the water level sensor is broken or surveys a wrong measure;
- The maximum water level that determines the stop of the filling;
- The minimum water level, under that the need for the evaporimeter filling-up (at the defined time), is detected. To obtain the right evaporation keep the evaporimetric basin always filled. Therefore set the minimum level like the maximum level, because, in case of too low water level, the shade of the walls on the surface of the water doesn't allow the right evaporation in the morning and in the evening.

5.5.3 Start precipitation alarm

(Logic used only for M-Log with terminal board inputs – ELO007 and ELO008 series)

The logic uses a measure connected to a rain gauge to detect the start precipitation conditions.

Can be set:

- The measure that samples the precipitation;
- The minimum time T1 after the first precipitation detection by means of the rain gauge (instantaneous value > 0);
- The minimum time T2 that must pass after the precipitation detection, meanwhile no precipitation is detected (no precipitation detection by the inner sensor of the rain gauge), to determinate the end precipitation condition;
- The minimum precipitation quantity that determines the start of the precipitation condition.

The alarm condition is detected when T1 time is passed after the first precipitation detection (and it's raining again), or is reached the specified rain quantity; anyway if T2 time is passed without any precipitation detection, the system goes to no alarm condition.

5.5.4 Flood alarm

(Logic used only for M-Log with terminal board inputs – ELO007, ELO008 and ELO011 series)

The logic uses a measure connected to a rain gauge to detect flooding conditions. Can be set:

- The measure that surveys the precipitation;
- The maximum precipitation quantity in a defined period;
- The minimum precipitation quantity in the same period;
- The length of alarm or not alarm period.

The alarm condition is detected when, within the specified period that starts from the first precipitation event, the maximum precipitation quantity is exceeded; from alarm condition beginning or at the end of the first period, are managed new periods and for each of them the rain totalization starts from zero; for each new period, if the rain fall quantity returns below the specified minimum value, the system returns in no alarm condition.

5.5.5 Threshold value compare

The logic detects value overflow or underflow by one or more measures (both univocally and simultaneously). To the threshold values can be applied a further hysteresis value; this can avoid continuous alarm state changes in case the measure value moves nearly around the threshold value. The comparison logics are the following:

- *Greater than*: alarm in case the measure value is greater than the threshold value added to the hysteresis; return to no alarm condition when the measure value is lesser than the threshold value minus the hysteresis; i.e. threshold value=4.0 and hysteresis=0.2 (alarm in shaded area):

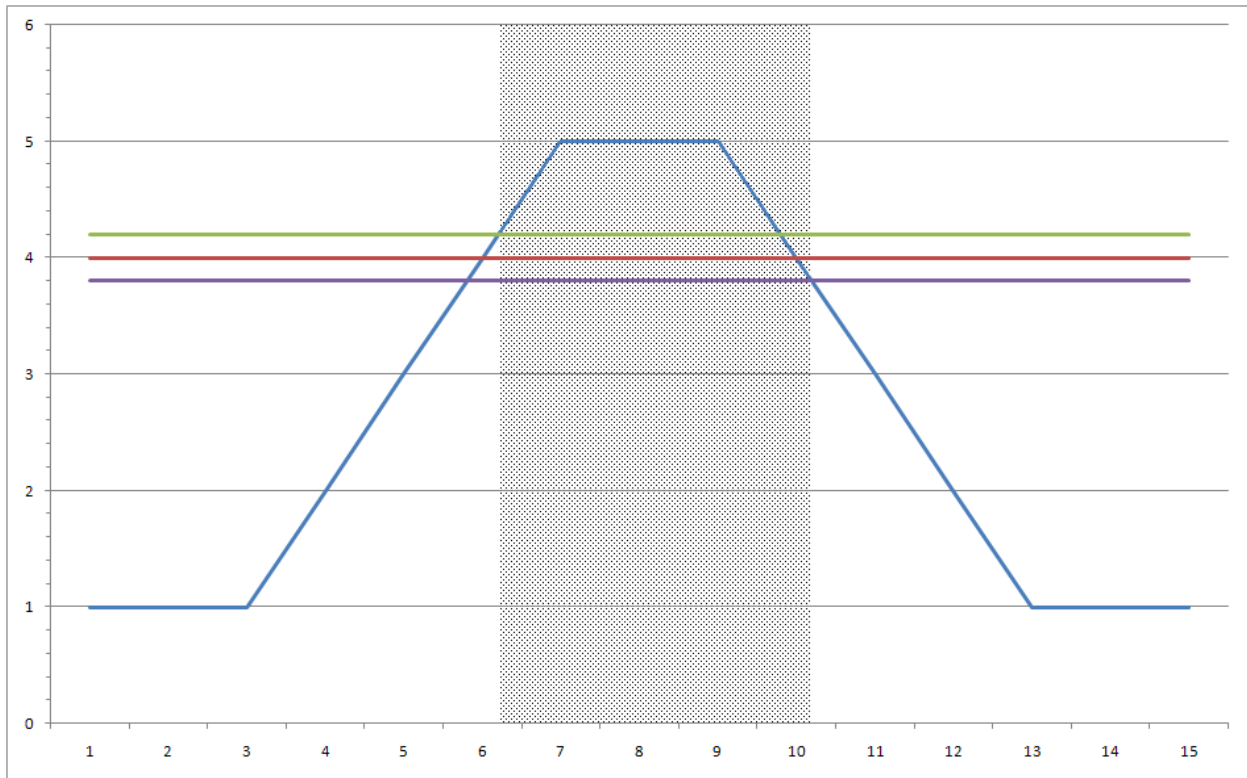

- *Lesser than*: alarm in case the measure value is lesser than the threshold value minus the hysteresis; return to no alarm condition when the measure value is greater than the threshold value added to the hysteresis; i.e. threshold value=4.0 and hysteresis=0.2 (alarm in shaded areas):

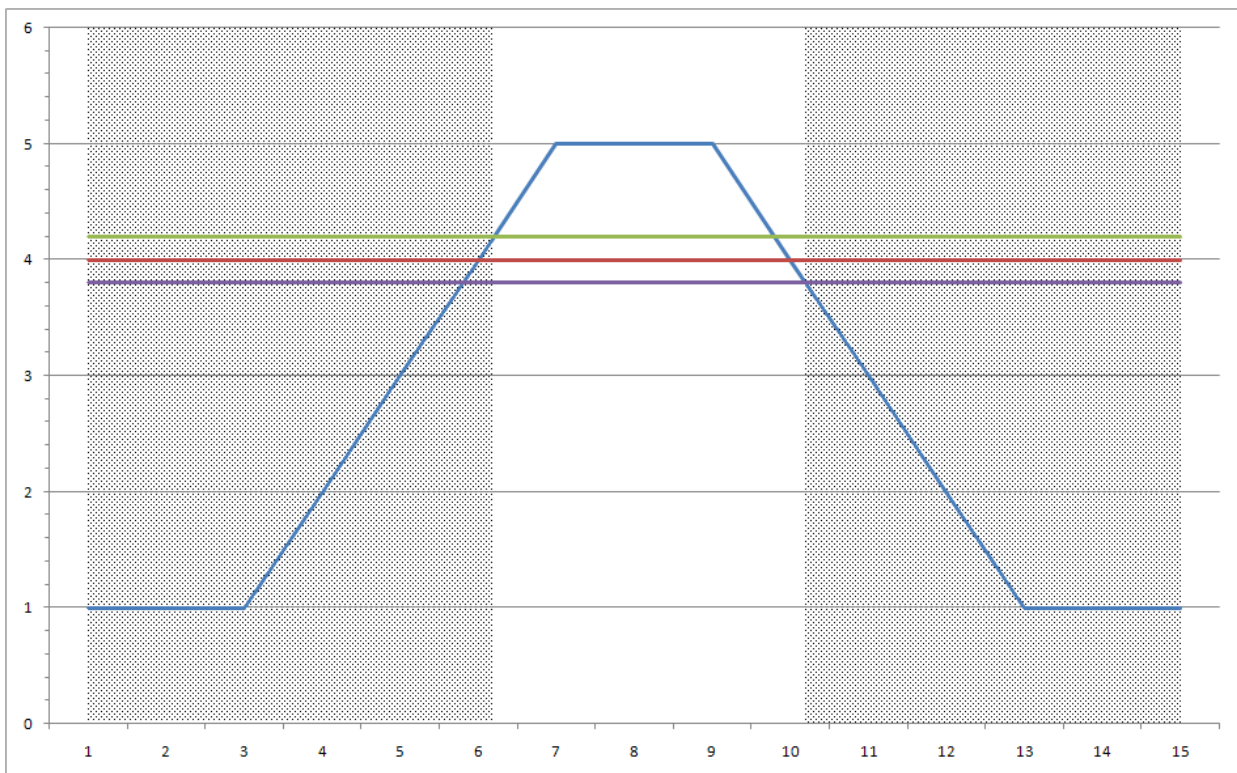

- Included:* alarm in case the measure value if greater than the minimum threshold value and at the same time lesser than the maximum threshold value; return to no alarm condition when the measure value is lesser than the minimum threshold value or greater than the maximum threshold; hysteresis is used like shown in the following example: threshold values=2.0 and 4.0 and hysteresis=0.2 (alarm in shaded areas):

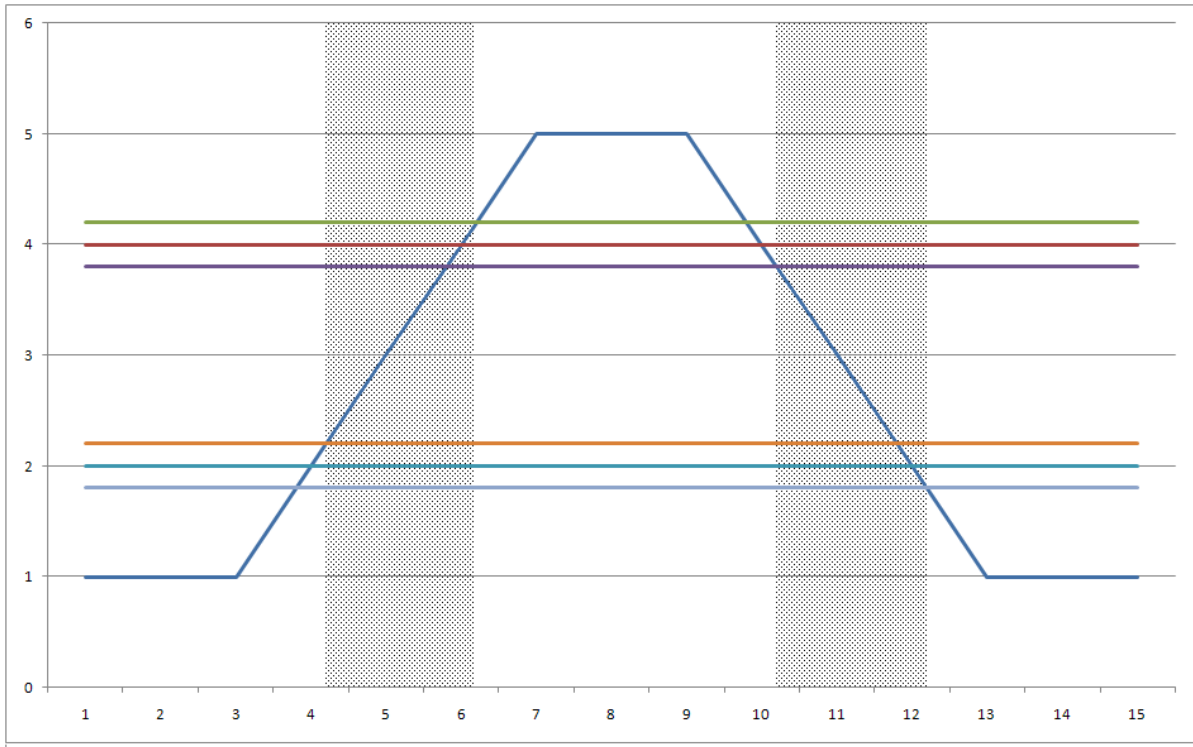

- Excluded:* alarm in case the measure value if lesser than the minimum threshold or greater than the maximum threshold; return to no alarm condition when the measure value is greater than the minimum threshold and at the same time lesser than the maximum threshold; hysteresis is used like shown in the following example: threshold values=2.0 and 4.0 and hysteresis=0.2 (alarm in shaded areas):

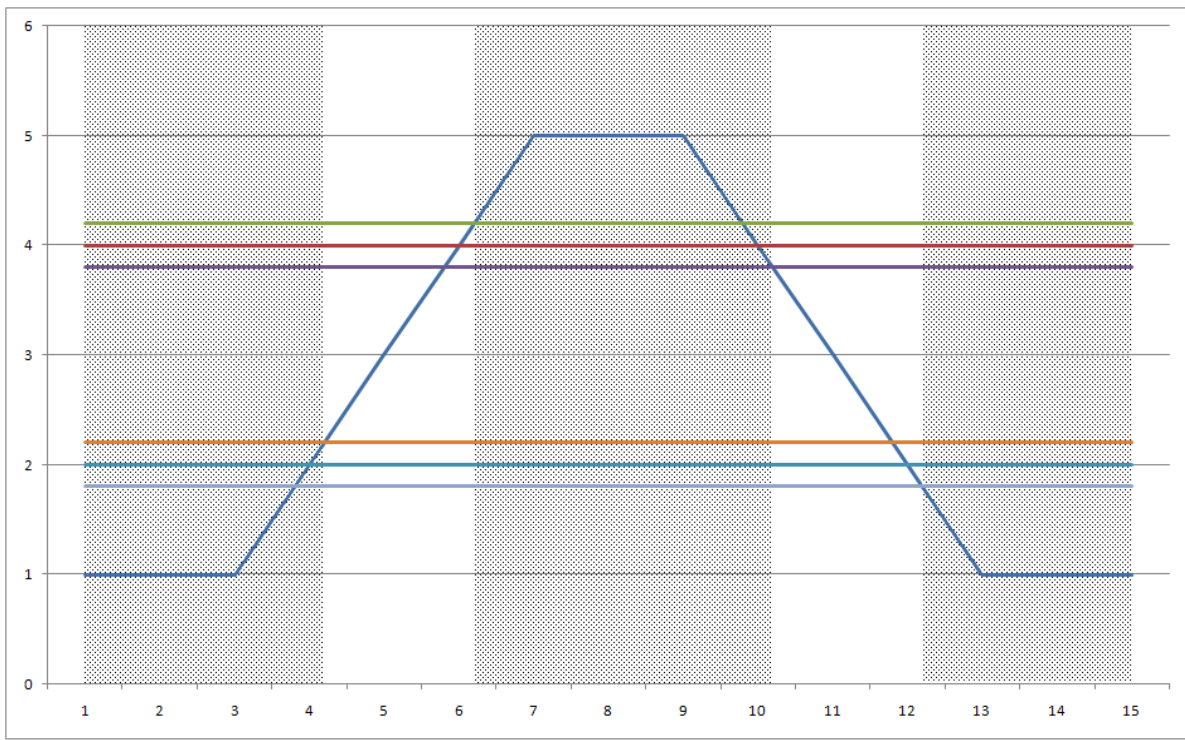

Threshold value compare algorithm can be applied to one or more measures; in the last case all used measures must be consecutively ordered (the list cannot include any measures that shouldn't be considered in the comparing), because the logic programming needs the ordinal numbers of the first and last measure. This logic can be programmed to detect the alarm condition only if all measures (that belongs to the selected set) or alternatively only one of them are contemporary over the stated limit.

Furthermore it's possible specify a minimum time (during that the measure stays over the set threshold value) to enter into the alarm condition and a minimum time to exit from the alarm condition. It can be done applying the algorithm to only one measure (i.e. it isn't possible to program the minimum times if two or more measures have been selected).

5.5.6 Timer

The timer logic allows: to activate or deactivate the actuator in two different times in the day, or alternatively to define a timed cycle on/off status. Can be set:

- Timer type (cyclic or time);
- The power-on delay after the initial instant determined by the cycle;
- If timer type is cyclic, the on and off statuses duration; the first cycle starts in the day time when the instrument clock time, divided by the sum of the two durations, returns zero as remainder; in this way the first cycle starts in a precise day time, not at any moment (i.e. if has been programmed 15 minutes *On* period duration, and 45 minutes *Off* period duration, the first cycle starts at the first hour and zero minutes after the instrument survey is started); the next cycles happen at set on/off times.
- If timer type is not cyclic, the day time of power on the actuator, and the day time of power off.

This logic is joinable with other logics in *AND* mode, for example to allow the alarms activation only in specified hours of the day.

5.5.7 Snow level alarm

(Logic used only for M-Log with terminal board inputs – ELO007 and ELO008 series)

The logic detects excessive snow fall conditions in indeterminate time period; the alarms condition stays active during programmable time; at the end of this alarm period the snow level starts to be counted from the actual level; if during the alarm condition the snow level decreases (owing to melting or autocompression), the snow level start value (used like reference value in the next delta calculation) updates accordingly. Can be set:

- The measure that samples the snow level;
- The maximum delta (centimeters), over that the system goes in alarm condition;
- The alarm duration before its automatic reset.

5.5.8 System error

The logic sets an alarm when the instrument detects and internal malfunction. All errors are detected as specified in §**Errore. L'origine riferimento non è stata trovata..**

5.6 Communication modes

M-Log has got different communication devices, that can be used to extend the connection capacities and modes to systems for data collection:

- RS232 serial port: at least one port (equipped with a double connector for applications where you want to interface M-Log with a DCE device or a DTE device) for each M-Log datalogger; two serial ports are available for ELO008 and ELO009 models; (see §**Errore. L'origine riferimento non è stata trovata.**)
- Xxx line driver: it lengthens the cable for serial connection up to 1 km or more; the connection speed is function of covered distance; you have always to install a couple of line drivers: one of them must be connected to RS232 serial port of M-Log, the other one must be connected to PC;
- RS232/Ethernet converter (code LSI LASTEM DEA550): it can be used with instruments equipped with RS232 serial line; it allows the communication using Ethernet LAN/WAN net, so virtually of any length; particularly ELO007 model has this converter built-in;
- GSM DEA714 Modem: it uses GSM network for connection to remote instruments; 9600 bps connection speed; it can be connected to serial port of M-Log; (see §**Errore. L'origine riferimento non è stata trovata.**)
- GSM/GPRS Modem (code LSI LASTEM DEA717 and DEA718): it uses GPRS packets transmission in order to allow the permanent transmission (with transmission rate according to choice) and rating according to traffic; it can be connected to serial port of M-Log and it's an application valid only for datalogger equipped with terminal board (series ELO007 e ELO008); (see §5.6.2)
- Bluetooth Adapter (code LSI LASTEM DEA300): it can be connected to serial port of M-Log (it's advisable use port serial 1, as able to handle sending large data frames, in excess of 128 B);
- External radio devices.

5.6.1 RS232 serial port

M-Log communicates with PC through 9 poles male/female not-reversing serial cable.

M-Log implements a particular system for activation of communication port: after 8 seconds of no-reception or no-transmission, the consumption goes down to first saving; after further 22 seconds the consumption goes down to minimum values. If you don't query M-Log continually, it communicates using very low energy consumption.

Every instrument uses a net address, that consists of a number with value included between 1 (default) and 200. If the instrument has been connected through network (radio) with other instruments, it's necessary to modify the address. The PC programs use the address of each definite instrument to select M-Log for sending of communication messages.

M-Log is compatible with LSI LASTEM sensors family equipped with CISS protocol. So it can be used in existing networks of LSI LASTEM cordless sensors, that make reference to E-Log, R-Log, Babuc ABC or receivers connected to PC directly. In this case M-Log can be programmed for spontaneous transmission, through serial port, of instantaneous data of acquired and calculated measurements; this parameter is available in mask for modification of *3DOM* communication

parameters, and it’s called *automatic transmission rate*. In this mode M-Log results like LSI CISS multi-channel sensor and so its measurements can be received by an other M-Log.

In addition to the CISS protocol, M-Log is able to manage, through serial port 2, other protocols:

- TTY (see §5.6.4);
- Modbus (see §5.6.5) ;
- Gill anemometer;
- Giletta GIL-D-I Ice sensor (only if it’s required);
- Aeroqual gas analyser;
- Hydrolab;
- Lufft UMB sensor (only if it’s required);
- Climatronics sensor.

A GSM or GPRS telephonic modem can be connected to serial port; in this case, if you want reduce the energy consumption of modem, it’s possible follow the instruction of §5.7. Anyway, if removed appropriately, the use of a modem doesn’t block the local communications with M-Log, connecting PC to serial port of instrument directly.

Note: in case PC has to execute any communication with the instrument through serial port, and the latter has been programmed for spontaneous transmission of data at frequent rate (intervals shorter than 10 s), PC could meet some difficulties to start first communication; so it could be necessary to start operation several times. After the reception of message, M-Log deactivates spontaneous communication for 1 minute, in order to make further communications with PC easier.

M-Log manages the flow check according to two choices (none, only RTS) that can be selected through configuration from 3DOM (see §4.4.4.3 of manual SWUM_00339 inside CD of LSI LASTEM – MW6501 products).

<i>Protocol / Device</i>	<i>Function</i>	<i>Com1</i>	<i>Com2</i>
(Owner) LSI LASTEM CISS	Transmission of instantaneous values of the measures (in polling mode or spontaneous transmission)	X	X
	Transmission and reset of elaborated data from memory	X	X
	Transmission of instrument registry information	X	X
	Transmission and setting of configuration parameters (measures, elaborations, communication, actuation logics, etc.)	X	X
	Transmission and reset of diagnostic information updated in real time or stored in memory (system log)	X	X
	Transmission of actuation logics state (allarms) or digital outputs state (actuators) (*)	X	X
	Transmission and setting of system date/time	X	X
	Setting of digital outputs (actuators)	X	X
	Acquisition of instantaneous values sampled from sensors with LSI LASTEM CISS protocol	X	X
	Management of system commands (start/stop survey, memory format, instrument reset, etc.)	X	X
TTY	Transmission of instantaneous values of the measures (in polling mode or spontaneous transmission)		X
	Transmission of instrument registry information		X
	Transmission and reset of diagnostic information updated in real time		X
	Setting of system date/time		X
Modbus RTU	Transmission of instantaneous values of the measures (fixed point or		X

	floating point)		
	Transmission and setting of digital outputs (actuators)		X
	Transmission of instrument registry information		X
	Transmission and reset of diagnostic information updated in real time		X
	Transmission and setting of system date/time		X
Aeroqual	Acquisition of sampled instantaneous values and transmission from connected instrument		X
Gill	Acquisition of sampled instantaneous values and transmission from connected instrument		X
Hydrolab	Acquisition of sampled instantaneous values and transmission from connected instrument		X
Climatronics	Acquisition of sampled instantaneous values and transmission from connected instrument		X
ZigBee	All commands provided in owner LSI LASTEM CISS protocol		X
PSTN/GSM Modem	Available in transparent mode with any protocol	X	X
GPRS Modem	Support to communication on TCP socket (encapsulation of the only owner LSI LASTEM CISS protocol), or with FTP protocol (transmission of elaborated data in binary format)	X	
RS232/Ethernet Converter	Available in transparent mode with any protocol	X	X

(*) Function obtained by programming of appropriate calculated measures

(**) Function available only for ELO007 and ELO008

5.6.2 Ethernet

M-Log can communicate through the use of Ethernet LAN/WAN network, so virtually of any length. M-Log offers to the user two possibilities in order to use this characteristic:

- external RS232/Ethernet converter connected to acquirer through ELA105 cable, supplied together with M-Log; sale code LSI LASTEM: DEA550; see § 5.6.2.1 for its configuration;
- Ethernet converter built-in datalogger, available only for M-Log model ELO007; see §5.6.2.2 for its configuration.

5.6.2.1 DEA550 converter configuration

In order to configure RS232/Ethernet converter prepare a PC with *HyperTerminal* of Windows and follow the instruction below:

1. Connect the converter to its power supply pack and to PC through proper serial cable (supplied together with DEA550) like specified in sheet supplied with product. Do not turn device on.
2. Set-up the switches for selection of serial type on “RS232” and red switch, placed opposite to serial, in “console” position; see plate on back of converter in order to set-up the position of switches.
3. At HyperTerminal opening, after you have given the name to work session, in “configure” session, set-up the exact COM to which converter is connected to PC; finally configure HyperTerminal with *9600, N, 8, 1, Nessuno parameters* referred to port where DEA550 has been connected.

4. Turn converter on and await for inscription “Login” on program. After login has been executed, the symbol # will be displayed; so type in “root” and then password “root” (press *Enter* key to continue the procedure an *Esc* key to come back).
5. Type in *EDITCONF* and press *Enter* key.
6. In order to change TCP/IP address, from main screen, select 1(Network configuration) and then again 1(IP configuration). Now modify values 2(IP address) and 3(Subnet mask) with values supplied by user.
7. Default port is 6000. In order to modify it (*Port*), from main screen, select 2(Serial port configuration), 1, 3(Host mode configuration) and finally 2(Port number) and here modify the value. Recommended port is 7001.
8. Change *Inter character time-out* from 0 to 10 ms. From main screen, select 2(Serial port configuration), 1, 4(Serial port parameters) and finally 7(Inter character time-out).
9. Type in sequence (always followed by *Enter*), *Save*, *Apply*, *Esc*.
10. Turn converter off and put red switch in position *data*.
11. Finally turn converter on again and connect it to M-Log.

5.6.2.2 XPORT configuration (internal Ethernet port)

For right operation, each M-Log must be configured according to special setups (for TCP/IP protocol) through DeviceInstaller of Lantronics software, available in DVD LSI LASTEM products (MW6501) in “Install\Support\Lantronix” folder or downloadable from Lantronics website <http://www.lantronix.com/support/downloads.html>

To configure Ethernet port, follow the instruction below:

1. Connect LAN cable in proper port on top panel of M-Log and check the flashing LED on the port, indicating the presence of the network.
2. Open DeviceInstaller software of Lantronics and following window will be displayed:

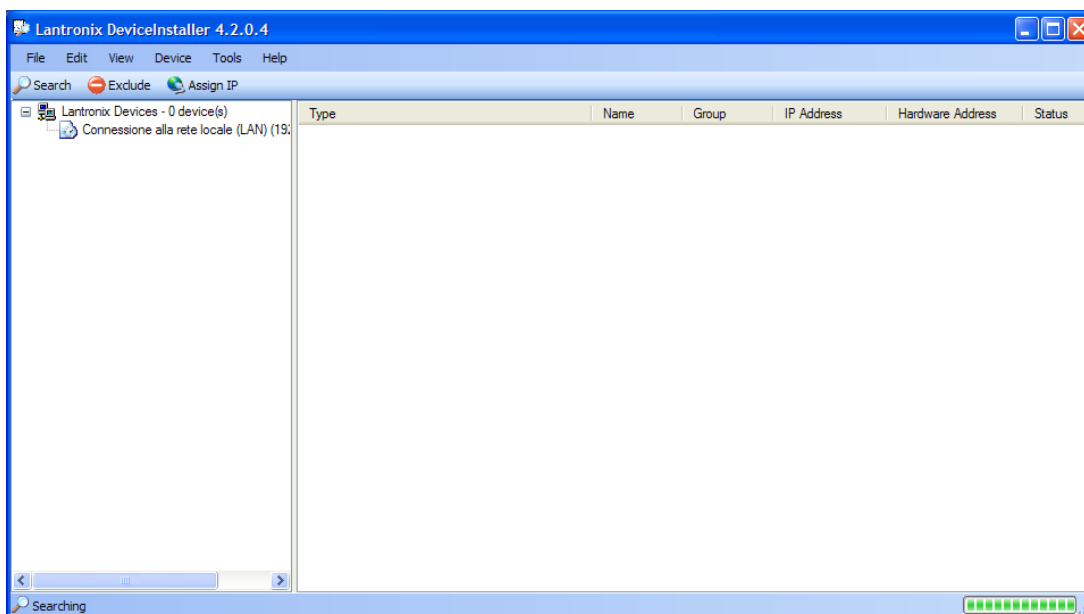

3. Press *Search* and identify the computer device connected to LAN. After some seconds, if LAN connection is operating properly, the instrument is recognized and listed among the available ones. In case of several instruments, it’s possible to determine each model according to hexadecimal numeric code written on label placed on bottom side of box.

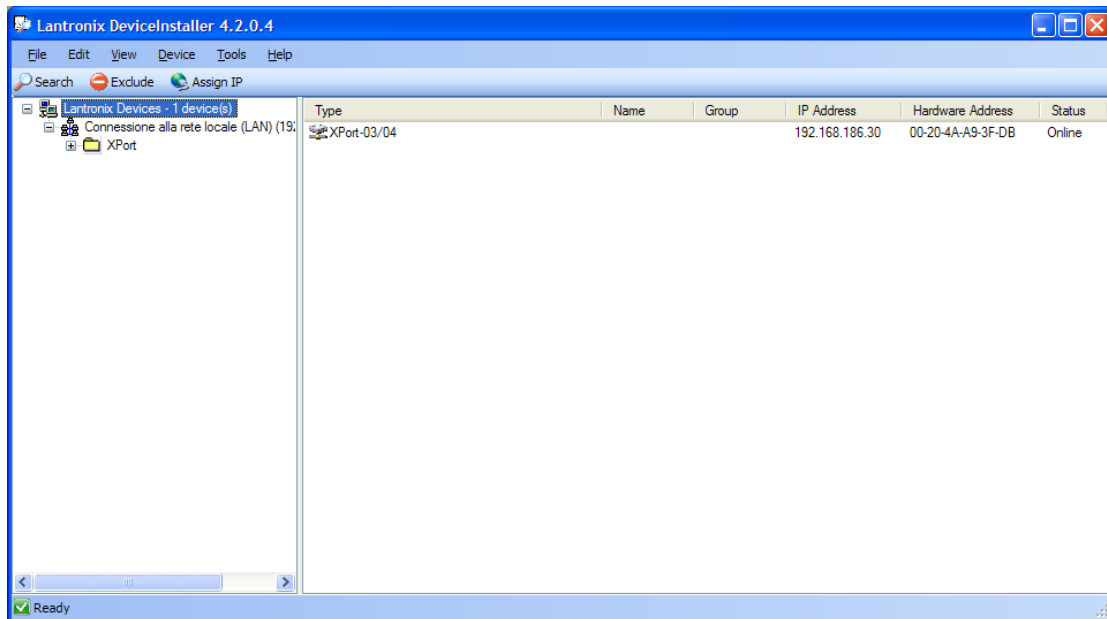

- The instrument use default DHCP protocol to obtain IP network address. Fix a static IP address and other indispensable network parameters. Ask these information to your administrator; in any case note these setups as you’ll have to enter them into communications setups of 3DOM. To modify the operation parameters: double click on device on right side of window, then select *Web configuration* session and click on green arrow button. Login window will be displayed asking for user name and proper password: like default the instrument is supplied with null user and password, so confirm immediately the not compiled input fields. Mask below will be displayed:

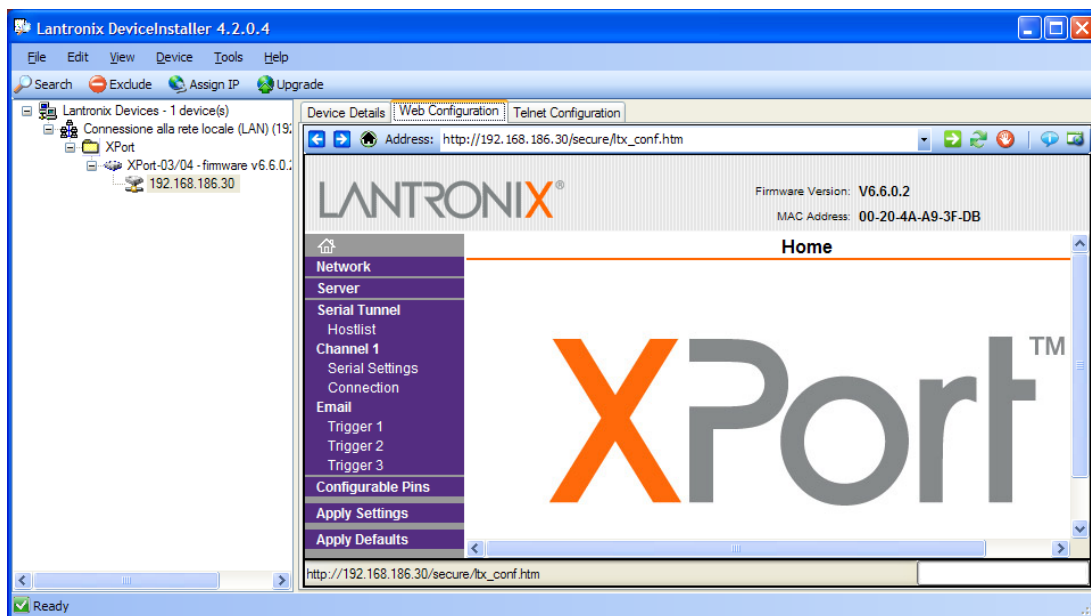

- Select *Network* session for programming of network parameters. Set the parameters previously selected (remember that the default setting of port is 10001, then, if possible, set that port in *Network->Connection->End point configuration->Local port*; if it isn’t possible, choose another port and set this in 3DOM program too) and then click on *Apply settings* command; await for some instants and repeat the starting operations to carry out new recognition of instrument, that now is operating in LAN network with new set parameters.

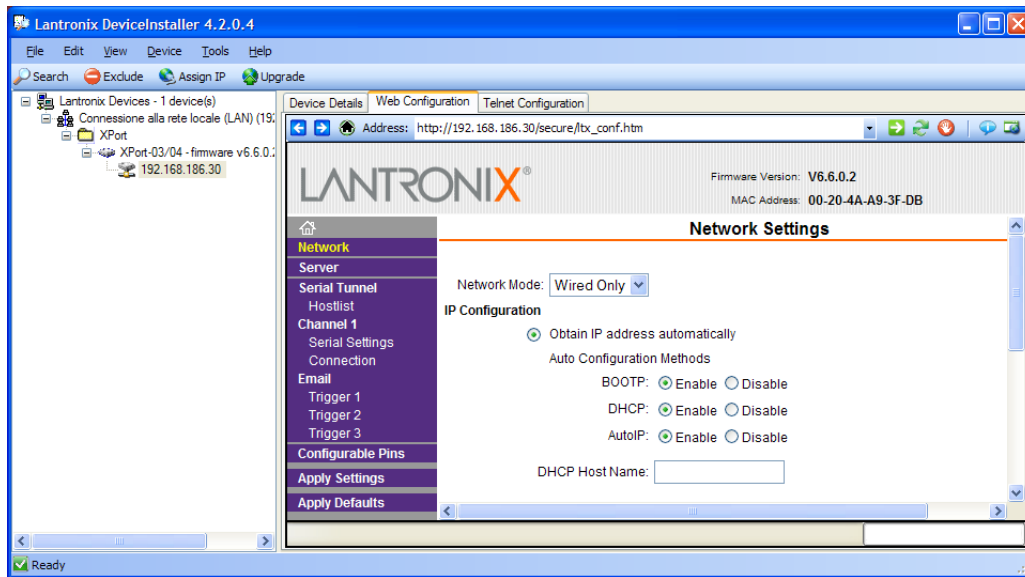

6. Select *Serial settings* session to modify setups of serial communication port. The only one possible modification is *Baud rate*. Choose and Select values from 1200 to 115200 bps, making attention to specify, through 3DOM program, same value for serial port 1 of LSI LASTEM instrument.

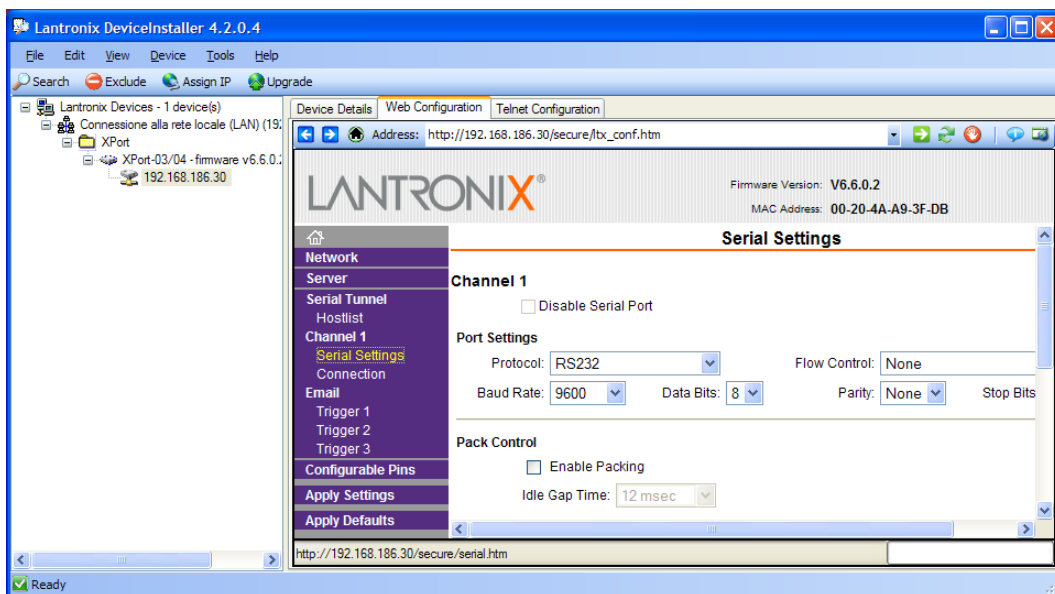

7. For modification of other advanced configurations make reference to online help of *DeviceInstaller* program.

5.6.3 Data trasmission through GPRS connection

GPRS data transmission system consists of the following parts:

- One or more M-Log instruments (only ELO007, ELO008 and ELO011 models);
- One modem GPRS LSI LASTEM Mod. DEA717 or DEA718 for each M-log, connected through ELA110 or ELA112 cable; the modem SIM card must be able to GPRS data transmission and the request of PIN code must be disable;

- One PC server with Windows operating system (Window XP or next version, Windows Server 2003 or next version), connected to Internet with a public IP address;
- LSI LASTEM *CommNetEG code BSZ306.2* program with use licence enabled for GPRS connections (only for transmission through TCP socket).

M-Log must be configured through *3DOM* program, in order to use GPRS modem and transfer the elaborated data with selected timing; the GPRS modem can be used only with serial port 1. In the configuration through *3DOM* software, remember to enable with *Yes* the field *Modem powered with actuator* in the *Serial communication port 1* window when the modem is powered using actuator 3 (recommended solution).

GPRS connection happens according to the spontaneous transmission rate programmed inside the system; therefore it happens according to the programmed timing (on the initiative of the instrument); you can also make a manual data transfer by pressing the button . The remote computer (that collects the data) consists of one TCP server, set on IP public address. The address of this server has been programmed inside GPRS modem connected to M-Log.

There are two different transmission’s modes:

- Through TCP socket;
- Through FTP protocol.

The TCP socket connection allows the use of minimum quantity of IP packets, and for this reason it’s cheaper than FTP protocol. Moreover one server (no special software installed in it) can transfer the data through TCP protocol.

In addition to the above-described parameters, set the following parameters through *3DOM* software in according to the selected transmission’s mode:

- for TCP mode, select *Switched off and on in case of failure* option in *Serial communication port 1* window;
- for FTP mode, select *Power on/off due to actuation logic* option in *Serial communication port 1* window to set the modem to switch off once a day. Then configure an actuation logic for leave the modem turned on all day except for a minute that will remain turned off; it is advisable to turn on the modem at least two minutes before the transmission.

M-Log will transfer the data to the operative centre at set timing. The parameters of the operative centre (IP address, IP port, user name, etc) have been specified inside *config.ini* configuration file (stored inside GPRS modem). In case of transmission through TCP socket the operative centre must be equipped with LSI LASTEM *CommNetEG code BSZ306.2* program. In case of transmission through FTP protocol, one FTP server must be available and working.

These are the reports of operational errors in GPRS transmission:

Symptom	Setting
Data not received through FTP/TCP socket	First installation

Cause-reason	GPRS diagnostic window	Resolution
Modem installation not correct	FSM: 3 and then 3 times GPRS Modem: N.C.	Check the connections of the serial cable and power supply (either directly or with actuator) according to the documentation.
Modem isn’t configured for GPRS	FSM: 3 and then 3	Contact LSI-Lastem.

connection	times GPRS Modem: N.C.	
SIM protected with <i>pin</i> code or not present or not suitable	FSM: 3 and then 3 times GPRS modem: N.C.	PIN code request must be disabled (use a normal cellular phone to do it). The SIM must be enabled to receive and transmit GPRS data.
COM 1 Port of M-Log not appropriately configured	FSM: 3 and then 3 times GPRS Modem: N.C. or no GPRS window	With 3DOM check the COM 1 port settings on the current instrument configuration, in particular the type of modem, power supply, the modem power type, the protocol type and the rate of spontaneous GPRS transmission.
Elaborations not available on M-Log (usually happens when you start a transmission in manual mode by pressing the suitable button on the instrument)	FSM: 11	Wait M-Log elaborations. It’s advisable to set the rate of spontaneous GPRS transmission greater or equal to the elaboration rate.
Low CSQ signal (<16)	FSM: 3, 7, 10 CSQ<16	Try to position the modem so that the signal is higher; possibly replace the antenna. CSQ values: 0÷32 (15 poor, 32 excellent).
Wrong FTP site or TCP address in modem configuration	All regular	Edit the configuration file of the modem. For more informations refer to the manual provided with the modem.

Symptom	Setting
Data periodically received through FTP/TCP socket	Installation has already occurred

Cause-reason	GPRS diagnostic window	Resolution
Low CSQ signal (<16)	FSM: 3, 7, 10 CSQ<16	Try to position the modem so that the signal is higher; possibly replace the antenna. CSQ values: 0÷32 (15 poor, 32 excellent).
The modem is turned off		If the M-Log doesn’t turn off , the issue depends by actuator configuration of the modem (actuator #7). Reprogram the actuator. If E-Log turns off, see the cause “E-Log is turned off”.
M-Log is turned off		Could be a M-Log power problem. In order to know when the last reset is happens, go to the instrument diagnostic window type 2 (§4.3.3 M-Log manual).

5.6.3.1 Use of DEA717 GPRS Industrial Plus modem

In order to install and configure DEA717 modem, see INSTUM_00519 manual supplied with the modem.

5.6.3.2 Use of DEA718 GT863-PY Telit modem

In order to install and configure DEA718 modem, see INSTUM_00518 manual supplied with the modem.

5.6.4 TTY Protocol

TTY protocol allows: the inquiry of the data acquired by simplified way (also from terminal), or the transmission of the instantaneous data of the measures by spontaneous mode.

For more informations about TTY protocol see INSTUM_00728_en manual reported on LSI LASTEM products DVD (MW6501).

5.6.5 Modbus Protocol

Modbus is a serial communication protocol used in industrial circle; it allows the communication between one *master* (usually PC) and one or more *slave* (devices for measurement, check or PLC) connected to the same network. Modbus sets-up the *master* and *slave*'s modes to start and stop the communication, it settles the modes for messages exchange and errors identifying too. Only *master* can start the communication.

There are two protocol versions: one serial version (RS-232 or RS-485) and one Ethernet version. The serial version includes two different communication modes: one RTU mode (where the data are packet in Hexadecimal format) and one ASCII mode (where the data can be easily read). In Ethernet version (like the RTU version) the protocol's packets are inside TCP/IP packets.

Every network device has its univocal address. A Modbus command includes the Modbus address of the instrument which want communicate with. Only this instrument will answer to the command, even though all instrument receive it. All Modbus commands include check information, that assure the correct reception of the command. The base commands can ask to a *slave* to change one value into one of its statuses or to return one or more values included into its registers.

E-Log looks like *slave* and implements part of the industrial Modbus protocol in RTU version on serial port RS-232.



For more informations about Modbus protocol see INSTUM_00728_en manual reported on LSI LASTEM products DVD (MW6501).

5.6.6 M-Log connected like master-slave mode

It's possible use two M-Log cascading, that is master/slave mode, especially when the number of physical inputs required by the application is higher than the number of physical inputs supplied by one M-Log datalogger. So we call *master* instrument the M-Log connected to host through direct connection or through communication apparatus, while *slave* instrument is connected only to master instrument. Using this configuration mode the slave instrument is a real multi-parametric serial sensor (from master datalogger's point of view).

In order to configure the system like master/slave mode follow the instructions below:

1. Physical connection:
 - Connect the serial port 2 of both dataloggers using null modem cable (LSI LASTEM code ELA121) or serial cable (LSI LASTEM code ELA105) with null modem adapter;
 - Connect the serial port 1 of M-Log master with the host through direct connection or through one communication apparatus.
2. During configuration through 3DOM software:
 - configure the slave instrument using only its measures (i.e. the measures that take-up their physical inputs) and don't setup any elaborations;

- configure the master instrument using both its measures (marked with symbol ) and the serial measures (marked with symbol ) coming from slave instrument; the serial measurements coming from slave instrument can be imported directly from *Import* function in 3DOM software selecting the correct configuration to be imported;
- check the agreement between the measures acquired from slave and the serial measures received from master (most of all the values of *Sensor’s Protocol Address* and *Index of measure in the sensor*); the uncorrect agreement prevent the master instrument from acquiring correctly;
- for M-Log master configure in serial communication parameters of port 2: *Protocol Type* =Native and *Velocity*=57600;
- for M-Log slave configure in serial communication parameters of port 2: *Network Address*=1, *Spontaneous transmission Rate* ≠0 (input one rate lower than the acquisition rate of fast serial measure set up on master; we recommend the input of slave’s transmission rate half of master’s acquisition rate) and Message transmission repetitions ≥1; see the following example:

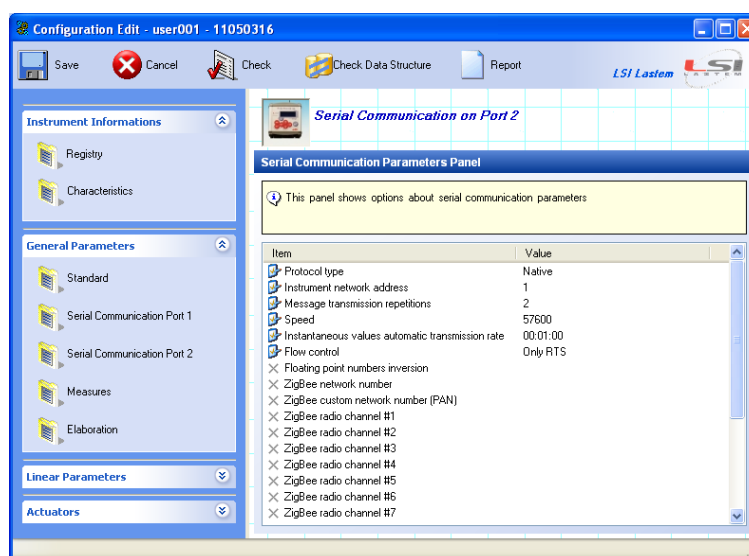

- for serial measures, that have to be received from master instrument, set up the *Sensor’s Protocol Address* equal *Instrument’s Network Address* selected for serial communication port 2 of slave instrument; recommended default value is 1.

So it’ll be possible the remote modification (through 3DOM software) of instrument’s configuration, but it won’t be possible the remote modification of slave’s configuration

5.7 Operating of low energetic consumption

There isn't a very configuration for low energetic consumption mode. Anyway in order to optimize energy consumption, proceed as follows:

- Use the highest possible value to program the acquisition rate of the measures, according to the dynamic feature of the quantity's signal to be sampled (see §**Errore. L'origine riferimento non è stata trovata.**);
- Keep the actuation time to energize the sensors low without compromising the reliability of the measure (see §**Errore. L'origine riferimento non è stata trovata.**);
- Use the lowest possible acquisition time required to, however, have the sensor send the measured signal in a correct manner (see §**Errore. L'origine riferimento non è stata trovata.**);
- Use a high rate, and only if necessary, to program the rate for probe control (see §5.2.6);
- Switch the display off manually or program it to automatically shut off by itself (see §4.3.5);

the display can be turned off by pressing of  button, while displaying the mask of measures;

- Disable the fast acquisition mode of the measures which was possibly enabled while the instrument was switched on (see §5.2.5).
- Cancel not-used actuation logics (see §**Errore. L'origine riferimento non è stata trovata.**);
- Manage modem switch on through actuator 3 (programmed with timed logic), or programming GPRS communication through modem activation;
- In case of sensors or telephone modems fed continuously, don't use instrument's batteries, but use other ones (if possible). In this way the instrument can operate even if modem and/or sensors aren't fed, and so they aren't operating;

ATTENTION: Default configuration programmed on instrument is not the one of lowest energetic consumption.

6 Appendixes

6.1 Technical specifications

A/D Convertitor (ELO011 excluded)	Resolution: 18 bit rounded to 16 bit Sample duration (rejection 50/60 Hz): 80 ms @ rejection 50 Hz			
Analogue inputs (ELO011 excluded)	Number of analog inputs: 4 in differential mode, 8 in single-ended mode			
		Scale	Resolution	Accuracy (@ 25°C)
	Voltage	-300 ÷ 1200 mV	40 µV	±100 µV
		±78 mV	3 µV	±35 µV
		±39 mV	1.5 µV	±25 µV
	Pt100	-50 ÷ 125 °C	0.003 °C	±0.05 °C
		-50 ÷ 600 °C	0.013 °C	±0.11 °C
	Resistance Ω	80 ÷ 140 Ω	0.0013 Ω	±0.02 Ω
		80 ÷ 320 Ω	0.005 Ω	±0.05 Ω
		0 ÷ 6000 Ω	0.19 Ω	±1.5 Ω
	Thermo couples	E-IPTS 68 -200 ÷ 1000 °C	< 0.1 °C	±1.5 °C
		J-IPTS 68 -50 ÷ 600 °C	< 0.1 °C	±1.2 °C
		J – DIN -50 ÷ 600 °C	< 0.1 °C	±1.2 °C
		K-IPTS 68 -150 ÷ 1350 °C	< 0.1 °C	±1.9 °C
		S-IPTS 68 0 ÷ 1600 °C	< 0.22 °C	±4.9 °C
T-IPTS 68 -200 ÷ 200 °C		< 0.1 °C	±1.4 °C	
ESD protection : <ul style="list-style-type: none"> • ±8 kV contact discharge IEC 1000–4-2 • ± 1.2 kV air-gap discharge IEC 1000–4-2 				
Channel to channel crosstalk: -93 dB Max input signal: 3 V Every input with EMC filter				
Error as a function of Environmental Temperature: <ul style="list-style-type: none"> • scale -300 ÷ 1200 mV < ±0.01% ES (@ -10 ÷ 30 °C) • scale ±39 mV < ±0.01% ES (@ -10 ÷ 30 °C) • scale ±78 mV < ±0.01% ES (@ -10 ÷ 30 °C) (ES= end of scale) Cold joint error as a function of Environmental Temperature: <ul style="list-style-type: none"> • Thermocouple E-IPTS 68 ±0.029/°C (@ 0 ÷ 50 °C) • Thermocouple J-IPTS 68 ±0.02/°C (@ 0 ÷ 50 °C) • Thermocouple J-DIN ±0.017/°C (@ 0 ÷ 50 °C) • Thermocouple K-IPTS 68 ±0.025/°C (@ 0 ÷ 50 °C) • Thermocouple S-IPTS 68 ±0.05/°C (@ 0 ÷ 50 °C) • Thermocouple T-IPTS 68 ±0.038/°C (@ 0 ÷ 50 °C) 				
Digital input	Functions: <ul style="list-style-type: none"> • Input for sensors with optoelectronics (freq. max 5 kHz); • Frequency input (freq. max 5 kHz); • Logic state input ON/OFF (they acquire signals 0 ÷ 3 Vdc). State level “low”: 0 ÷ 1.5 V State level “high”: 2 ÷ 3 V Max input frequency: 5 kHz Max error.: 3 Hz @ 5 kHz Protection: Transient voltage suppressor: 600W, t > 10 µs			
Total measures	50 (total measures referred to sensors acquired from terminal board or serial port/radio and			

	calculated measures)
Derived calculations	Function library for derived calculations applied to acquired measures or calculated: <ul style="list-style-type: none"> • Mobile statistic (minimum, arithmetic average and ed angular, maximum: statistic sliding from 2 to 128 values) • Crossed statistic (average and instantaneous totalization from 2 to 5 measures)
Actuators output	Nr. outputs: 2 (mod. ELO011 excluded) +1 on pin9 of the connector of serial port 1 Max current for a single powered output: 150 mA Protections: thermal and for overloaded current (> 0.15 A)
Power	Input voltage: 8 ÷ 14 Vdc charger Average power consumption (without probes feed, @ 4.2 Vdc): <ul style="list-style-type: none"> • Illuminated display power on: 200 mW • 4 channels acquisition: 2 mW • Radio power on: 200 mW • Power down: < 1 mW Protections: <ul style="list-style-type: none"> • Internal overcurrent, shortcircuit • Max actuator current, with external load: 1.5 A • Transient voltage suppressor: 600 W, t > 10 µs • Polarity inversion
Internal battery	Internal battery: rechargeable LiIon 1950 mAh, 4.2 Vdc Recharge time: about 8 hours Discharge time (energetic autonomy exclusively with a new and full charged battery): about 9 months
Actuation logics	3 actuators (only 1 for the model ELO011) with 10 actuation programmable logics; activation of outputs according to AND o OR logics applied to one or more actuation logics: <ul style="list-style-type: none"> • Feeding of sensors with automatic anticipation • Daily timer (hour of activation and hour of deactivation) • Cyclic timer (ON status time, OFF status time) • Overcoming of threshold value (limits and hysteresis) • Logics for outdoor applications (according to the M-Log model): eolic alarm, evaporimeter filling, flood alarm, snow level alarm) • Manual power on and power off
Measures elaborations	Statistical algorithms for arithmetic and vectorial elaborations, uniquely programmable for each measure, calculated on single time base, from 1 second to 12 hours, for all measures. (default elaboration rate of measures: 10 minutes)
Communication protocols	Serial port: Native (CISS) for instrument configuration, internal clock date/time setting, data download (instantaneous and elaborated measure values and diagnostic informations); GPRS transmission support (TCP or FTP mode). Radio: data acquisition from probes or LSI LASTEM datalogger with CISS protocol
Communication lines	<ul style="list-style-type: none"> • RS232 main serial line, communication speed from 1200 to 115200 bps, function of instrument configuration and reception of instantaneous and elaborated data through LSI LASTEM protocol; Bluetooth connection option • Ethernet RJ45 connection with TCP/IP protocol • RS232 second serial line, communication speed from 1200 to 115200 bps; function of instrument configuration and reception of instantaneous and elaborated data through LSI LASTEM protocol; availability of MODBUS and others protocols; connection to GSM/GPRS modem
Internal calendar clock	Format: year-month-day-hour-minutes-seconds Drift: 30 seconds/month (@ T = 25 °C)
Display	Alphanumeric, 4 x 20 charaters, illuminated with programmable power off Functions displayed: <ul style="list-style-type: none"> • Instantaneous values of acquired sensors and calculated measures; • Signal of measures in allarm according to actuation logics; • Diagnostic of actuators state; opportunity of instantaneous modify of actuator activation state; • Diagnostic of communication lines and protocols; • Communication diagnostic (radio and GPRS); • Diagnostic data memory; • Product presentetion window of the instrument.
Keyboard	Membrane, 8 keys, indicators (LED) that display the operation state of instrument (OK/ERR), the

	communication from and to external devices (Rx/Tx) and the charge-condition of inner battery
Processors	1 RISC 8 bit, clock 8 MHz
Mechanic protection	IP 40
Operating temperature	-20 ÷ 60 °C, 15 ÷ 100 % UR (no condensing)
Weight	About 500 g
Dimensions	140 x 120 x 50 mm

6.2 Function library for derived calculations

M-Log has a useful library containing deriving quantities, featuring application functions dedicated to both indoor (microclimate) and outdoor (meteorology) environmental sectors.

The list below shows all calculation functions available:

- **Arithmetical calculations**
 - Addition-summation
 - Subtraction
 - Multiplication
 - Division
- **Statistical/mathematical operations**
 - Integral
 - Mean
 - Power
 - Exponential
 - Natural logarithm and base 10
 - Square root
- **Mobile calculations (programmable from 2 to 128 values)**
 - Minimum, average, maximum
 - Totalization
 - Angular average (only for ELR515 and ELR516 models)
- **Thermo-hygrometric quantities (UNI EN ISO 7726, ISO/WD 7730, VDI 3786)**
 - Relative humidity with psychrometric calculation (dry/humid bulb)
 - Absolute humidity
 - Specific humidity
 - Mixing factor (ratio)
 - Humid air enthalpy
 - Dew point temperature
 - Partial steam pressure
 - Humidity index (HI)
 - Discomfort of heat index
 - Indoor and outdoor WBGT index
 - Wind chill index
 - Chill temperature (TCH)
 - Mean radiant temperature
 - Radiant temperature asymmetry (only for ELO009 models)
 - Average planar radiant temperature (only for ELO009 model)
 - Planar temperature side 1 and side 2 (only for ELO009 models)
 - Percentage of dissatisfied people due to radiant temperature asymmetry from wall or ceiling (only for ELO009 models)
 - Dissatisfied floor temperature (only for ELO009 models)
 - Dissatisfied vertical temperature from 10 to 110 cm (only for ELO009 models)
 - Draught rating (only for ELO009 models)
 - Operative temperature (only for ELO009 models)

- **Duct flow**
 - Air speed from differential pressure (Pitot or Darcy)
 - Volumetric air and mass flow
 - Number of air changes

- **Radiometry and illuminance**
 - Insolation time
 - UV index (DLE)
 - UV exposure level
 - Light intensity (only for ELO009 models)
 - UVA density (only for ELO009 models)
 - Day light factor (only for ELO009 models)

- **Actuators operations(*)**
 - Actuation status calculated with AND operator
 - Actuation status calculated with OR operator
 - Actuation logics status calculated with AND operator
 - Actuation logics status calculated with OR operator

- **Others**
 - Evaporation calculation based on the evaporimeter level (only for ELO007 and ELO008 models)
 - Soil volumic humidity with permittivity
 - Atmospheric pressure at sea level
 - Total count
 - Delta with previous value
 - Detection and warning of low battery status of one or more sensors received through CISS protocol

(*) Calculated measures available only for M-Log datalogger with firmware from 2.3 version; calculated measures associated with 3DOM software from 3.8 version.

These measure are set a fixed update time of 1 second: the update of value of calculated measure on the actuator is always 1 second delay compared to the status recorded by internal actuation logic.

Now is therefore possible to process and record the actuator status or display it as an instantaneous value without having to carry the electrical signal of the actuator in an input of the datalogger. Now it is also possible make complex algorithms through a combination of actuation logics status with other calculated measures (typically addition and multiplication), overcoming the limits of the use of a single operator (AND and OR) and giving the inputs for the acquisition of real sensors.

With *3DOM* you can choose which quantities to have the instrument calculate and select the direct measures which allow their calculation.

Some calculations, frequently used in agro-meteorology, such as wind direction or integral radiation, are easily obtained from the integral mathematical calculation.

6.3 Error messages

M-Log indicates errors by triggering the red led *Err* located on the instrument's keyboard: the kinds of errors, listed in the following table, are indicated by the blinking modes.



Number of blinkings	Type of problem	Troubleshooting
1	Data memory access	Try to transfer the data elaborated by the instrument; then send the configuration again to the instrument using <i>3DOM</i> (see § Errore. L'origine riferimento non è stata trovata.); if the error occurs again, contact LSI LASTEM technical support
3	Acquisition from sensors	Use <i>3DOM</i> to check the congruence of the acquisition parameters of the measures in the current configuration; send the configuration again to the instrument (see § Errore. L'origine riferimento non è stata trovata.); should a new error occur, contact LSI LASTEM technical support for assistance including the current configuration file
4	Parameter configuration	Transfer the data elaborated by the instrument; then send the configuration again to the instrument using <i>3DOM</i> (see § Errore. L'origine riferimento non è stata trovata.); if the error occurs again, contact LSI LASTEM technical support for assistance including the current configuration file
5	Search data in memory	If the error occurs immediately after switching on the instrument, reset the error and continue using the instrument as usual; should a new error occur while operating the instrument with no communication with the PC, contact LSI LASTEM technical support; should the error occur while requesting the elaboration in memory by the program <i>3DOM</i> , try requesting the data again using a different date/time (try using a previous date first; should a new error occur, try later dates); should the error persist, switch the instrument on and off and request all data indicating a date/time definitely prior to the first date in memory; upon completion of the data transfer, cancel them; should the error occur again send the configuration of the instrument to LSI LASTEM technical support describing the problem.
6	Protocol CISS	Use <i>3DOM</i> to check the congruence of contents parameters in the current configuration; send the configuration again to the instrument (see § Errore. L'origine riferimento non è stata trovata.); should a new error occur, contact LSI LASTEM technical support for assistance including the current configuration file

When the instrument finds an error, it also indicates it as follows:

- 1) By activating the digital signal of the error;
- 2) By displaying the numeric value of the error found: the error code appears on the visualization window of the diagnostic data type 1; the numeric code can actually indicate more than one error; the displayed value is expressed with a hexadecimal number; the errors that correspond to the value that appears on the display can be easily interpreted by means of program *3DOM* (menu *Instruments*);
- 3) By communicating with program *3DOM*: while the instrument transfers the elaborations or sends the configuration data, the programs may show the code of the error found by the instrument.

6.3.1 Disabling error signalization

There are two possibilities to disable error signalization:

- 1) Press key  and  while the error code is being displayed in the diagnostic window type 1 to reset the error (it will however remain on the display when you leave and call the diagnostic window);
- 2) While the data is being transferred between instrument and PC: in this case the instrument resets the error since it considers that the error has already been found by the person using the computer.

In both cases the reset operation will locally switch off the optical indicator *Err*, eliminate the error number from the diagnostic window type 1 and disable the signal in effector's output (if programmed by respective actuation logic). The error reset will remain until the instrument finds a new possible error; in this case the instrument will activate the error signalization mode again as previously described.

6.3.2 Error found in measure

The values indicated by the measures (instantaneous values) may indicate the error status (*Err*), in the following conditions:

- If the measure is acquired:
 - Programming of a measure incompatible with the type of signal to be measured (electrical type selected, linearization type, scale recalculation parameter, etc.);
 - Sensor is interrupted or is not correctly connected to the terminal board (see §**Errore. L'origine riferimento non è stata trovata.**);
 - If the sensor is powered by an energized output, the starting time might not be enough;
 - The electrical input signal (to the instrument) is out of scale;
 - In case of thermocouple measure, the cold junction temperature (internal temperature) might not be programmed;
 - In case of measure acquired from serial port: no valid message has been detected coming from the sensor during time corresponding to more then treble set acquisition rate.
- If the measure is calculated:
 - Out-of-scale or in-error value from one or more dependant measures allocated to the measure to be calculated;

- Error in output to the algorithm of the calculated measure;

When the number to be displayed is < -999999 or > 9999999 , E-Log points out the anomaly of measure in overflow with “Overfl.” error status.

6.3.3 Low battery signalization

The low battery signalization occurs on datalogger through three times blinking of LED ■-Err; the error LED blinking disappears automatically in instrument when the battery becomes charged.

In the following table there are values of battery voltage to trigger the alarm condition:

<i>Condition</i>	<i>Battery voltage</i>
Minimum voltage of battery to “keep alive” the instrument	3,3 V
Minimum voltage of battery to trigger the alarm condition	3,5 V
Minimum voltage of battery to operate with the survey	3,7 V

6.4 Instrument maintenance

M-Log does not require special maintenance interventions when installed according to the general safety rules indicated in §**Errore. L'origine riferimento non è stata trovata.**

However, we recommend that LSI LASTEM staff carries out periodical check of whole installation (M-Log and sensors connected to it) at regular intervals in order to point out and correct possible measurement errors.

6.5 Declaration of conformity



LSI LASTEM S.r.l.
Via Ex S.P. 161 Dosso, n.9 - 20090 Settala Premenugo (MI) - Italia
Tel.: (+39) 02 95 41 41 **WEB:** <http://www.lsi-lastem.it>
Fax: (+39) 02 95 77 05 94 **Ch./P. Iva:** (VAT) IT-04407090150
e-mail: info@lsi-lastem.it **REA:** 1033021 **Reg. Imprese:** 04407090150



DICHIARAZIONE DI CONFORMITA' CE CE Conformity Declaration

Produttore: **LSI LASTEM s.r.l.**
Applicant Via Ex S.P. 161 Dosso, n.9 – 20090 Settala Premenugo (MI) – Italia

Con la presente si dichiara che tutti i prodotti della seguente serie:
We hereby declare that all the products of the following series:

Datalogger per applicazioni ambientali modelli:
Datalogger for environmental applications models:

- **ELO007 – ELO008 – ELO009**

a cui questa dichiarazione si riferisce è conforme ai requisiti essenziali dei seguenti standard e documenti normativi:

to which this declaration relates, is in conformity with the relevant provisions of the following standard and other normative documents:

EN 60950-1 (2005-2006), EN 50371 (2002-10),
EN 301489-17 (2002-08); EN 300338 (2006-10);
EN 61326-A1 (1997) + A1 (1998) + A2 (2001) + A3 (2003)

che rispettano le direttive:
following the provisions of the Directive:

R&TTE Directive (1999/5/EC)

Settala, giugno 2011

Dr. Giulio Certo
Direttore Generale e Legale Rappresentante